

Service Manual

Telephone Equipment

Model No. **KX-TG5776S**
KX-TG5777S
KX-TGA571S

5.8 GHz Expandable Digital Cordless
Answering System

5.8 GHz Expandable Digital Cordless
Answering System with Two Handsets

Silver Version

(for U.S.A.)

Supplement-4

Please file and use this supplement manual together with the service manual for Model No. KX-TG5776S/ KX-TG5777S/KX-TGA571S, Order No. KM40602997CE.

WARNING

This service information is designed for experienced repair technicians only and is not designed for use by the general public. It does not contain warnings or cautions to advise non-technical individuals of potential dangers in attempting to service a product. Products powered by electricity should be serviced or repaired only by experienced professional technicians. Any attempt to service or repair the product or products dealt with in this service information by anyone else could result in serious injury or death.

TABLE OF CONTENTS

	PAGE
1 REPLACEMENT PARTS LIST -----	2
1.1. REFERENCE CHART-----	2
1.2. ORIGINAL AND NEW PARTS COMPARISON LISTS-----	2
2 CHANGES -----	3
2.1. Accessories and Packing Materials (KX- TG5776S)-----	3
2.2. Accessories and Packing Materials (KX- TG5777S)-----	4
2.3. Accessories and Packing Materials (KX- TGA571S)-----	5
3 ADDITION -----	6
3.1. Cabinet and Electrical Parts (Handset)-----	6









Panasonic[®]

© Panasonic Communications Co., Ltd. 2009. Unauthorized copying and distribution is a violation of law.

1 REPLACEMENT PARTS LIST

1.1. REFERENCE CHART



Reason for Change	
*The following items (1-8) indicate the reason for change. See the "Notes" column for each part in ORIGINAL AND NEW PARTS COMPARISON LISTS .	
1. Improve performance	Notes: *1: AC adaptor is fully compatible, so the filter does not need to be changed. Remark: *c: To share the parts with other models. *i: Because of sales company demand.
2. Change of material or dimension	
3. To meet approved specification	
4. Standardization	
5. Addition	
6. Deletion	
7. Correction	
8. Other	

Interchangeability Code		
**The following items (V-Z) indicate the Interchangeability. See the "Notes" column for each part in ORIGINAL AND NEW PARTS COMPARISON LISTS .		
V	Original  Early (before change) New  Late (after change)	Original or new parts may be used in early or late production sets. Use original parts until exhausted, then stock new parts.
W	Original  Early (before change) New  Late (after change)	Original parts may be used in early production sets only. New parts may be used in early or late production sets. Use original parts where possible, then stock new parts.
X	Original  Early (before change) New  Late (after change)	New parts only may be used in early or late production sets. Stock new parts.
Y	Original  Early (before change) New  Late (after change)	Original parts may be used in early production sets only. New parts may be used in late production sets only. Stock both original and new parts.
Z	Other	

Note:

Alphabets in the "Remarks" column in the following lists correspond to the alphabets in the "Remarks" in REFERENCE CHART.

1.2. ORIGINAL AND NEW PARTS COMPARISON LISTS

Ref. No.	Part No.		Part Name & Description	Pcs/ Set	Remarks	Notes	Time of Change (Suffix)
	Original (Old)	New					
Handset							
127	-----	PQHS10622Z	SPACER, SPEAKER NET	1	*c	5 -	---
Accessories and Packing Materials (KX-TG5776S)							
A1	PQLV207Z	PQLV219Z	AC ADAPTOR *1		1	*i	4 W ---
Accessories and Packing Materials (KX-TG5777S)							
A101	PQLV207Z	PQLV219Z	AC ADAPTOR *1		1	*i	4 W ---
Accessories and Packing Materials (KX-TGA571S)							
A201	PQLV207Z	PQLV219Z	AC ADAPTOR *1		1	*i	4 W ---

2 CHANGES

2.1. Accessories and Packing Materials (KX-TG5776S)

[Changed from original section "16.4. Accessories and Packing Materials (KX-TG5776S)"]

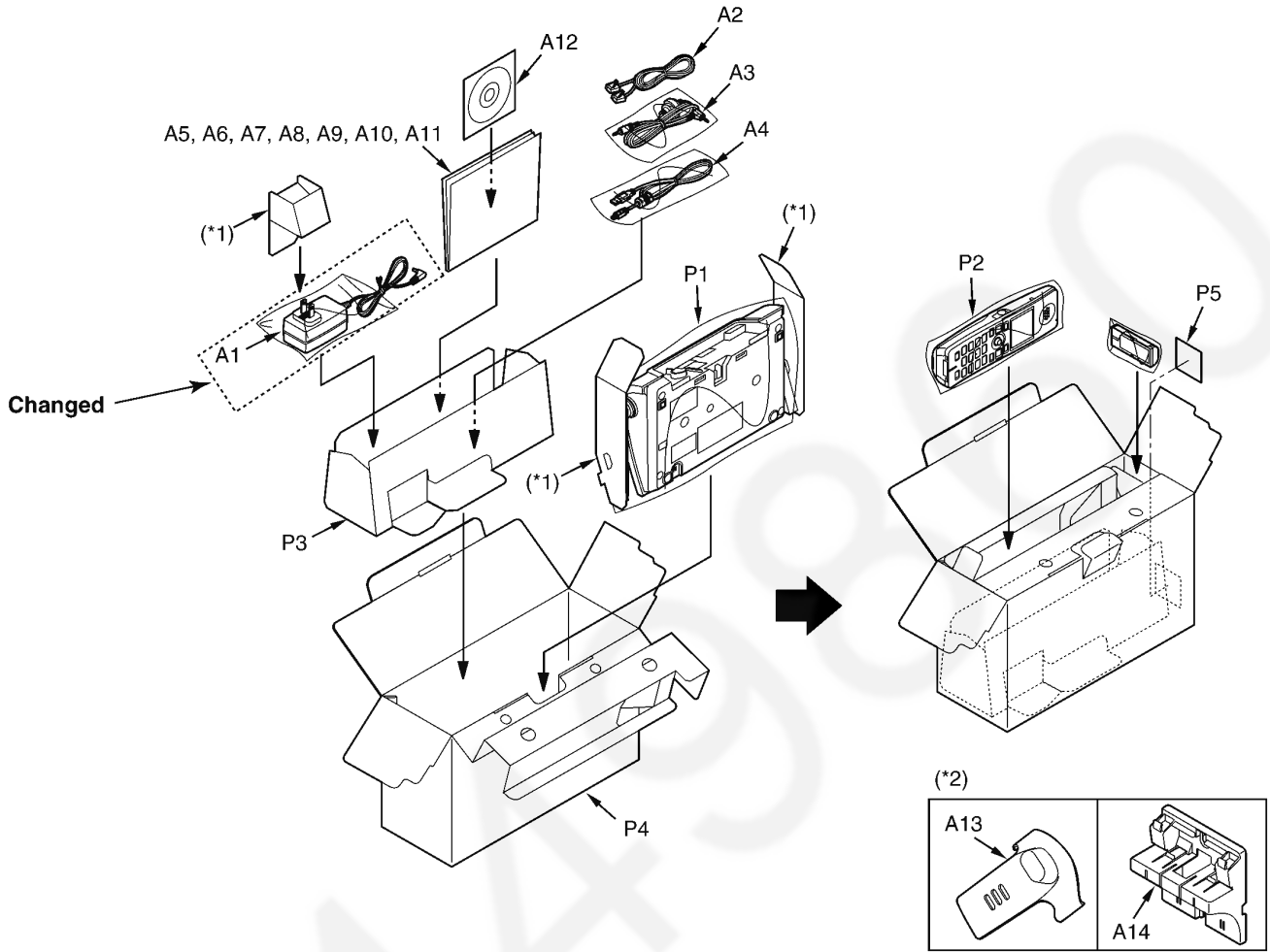

Note:

(*1) These pads are pieces of Ref No. P3 (CUSHION).

(*2) for Service

2.2. Accessories and Packing Materials (KX-TG5777S)

[Changed from original section "16.4.2. Accessories and Packing Materials (KX-TG5777S)"]

Changed

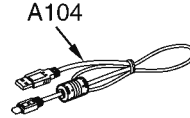
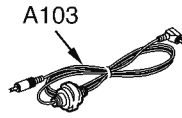
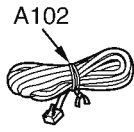
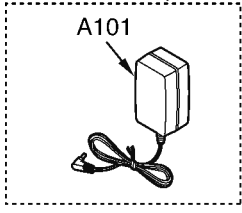

A105, A106, A107, A108,
A109, A110, A111

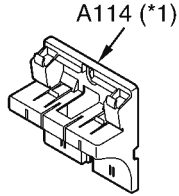
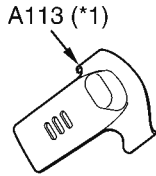
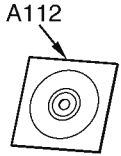

Note:
(*1) for Service

2.3. Accessories and Packing Materials (KX-TGA571S)

[Changed from original section "16.4.3. Accessories and Packing Materials (KX-TGA571S)"]

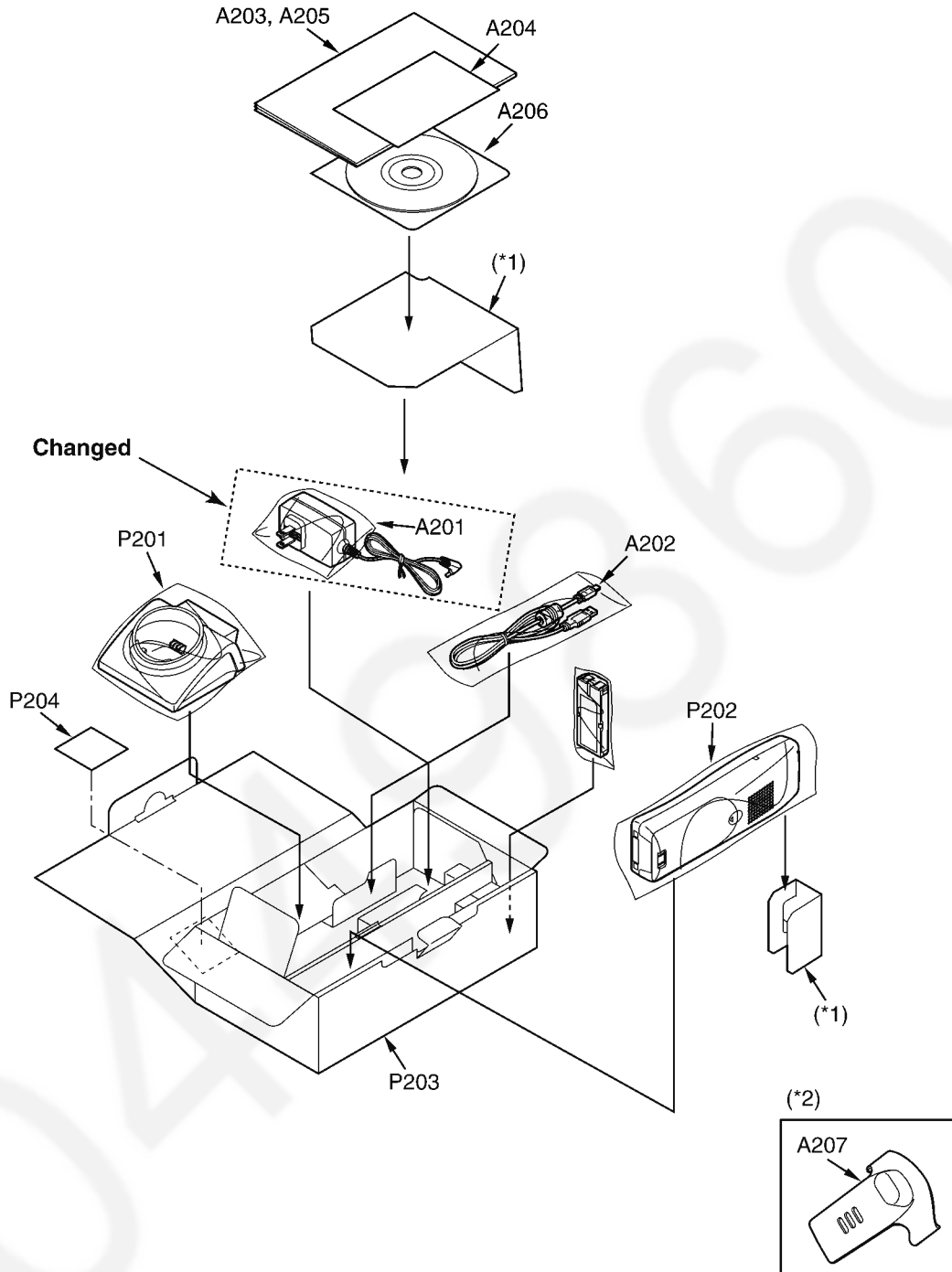

Note:

(*1) These pads are pieces of Ref No. P203 (GIFT BOX).

(*2) for Service

3 ADDITION

3.1. Cabinet and Electrical Parts (Handset)

[Added into original section "16.2. Cabinet and Electrical Parts (Handset)"]

