

Service Manual

Rice Cooker

Model No. **SR-
W18FGSWUA**

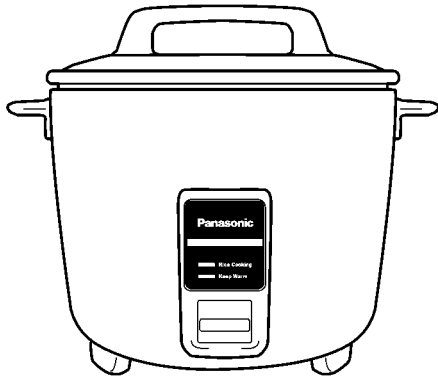

Chassis

Product Color

Destination

NEPAL, PGF, SRILANKA, BANG-
LADESH, TAHITI, MOLDIVES, MAURI-
TIUS

⚠ WARNING

This service information is designed for experienced repair technicians only and is not designed for use by the general public. It does not contain warnings or cautions to advise non-technical individuals of potential dangers in attempting to service a product. Products powered by electricity should be serviced or repaired only by experienced professional technicians. Any attempt to service or repair the product or products dealt with in this service information by anyone else could result in serious injury or death.

IMPORTANT SAFETY NOTICE

There are special components used in this equipment which are important for safety. These parts are marked by ⚠ in the Schematic Diagrams, Circuit Board Diagrams, Exploded Views and Replacement Parts List. It is essential that these critical parts should be replaced with manufacturer's specified parts to prevent shock, fire or other hazards. Do not modify the original design without permission of manufacturer.

TABLE OF CONTENTS

	PAGE	PAGE
1 Safety Precautions -----	2	
2 Specifications -----	3	
2.1. SR-W18FGSWUA-----	3	
3 Location of Controls and Components -----	4	
4 Troubleshooting Guide -----	5	
5 Schematic Diagram -----	6	
5.1. SR-W18FGSWUA-----	6	
6 Exploded View and Replacement Parts List -----	7	
6.1. Exploded View-----	7	
6.2. Replacement Parts List-----	8	

Panasonic



© Panasonic Corporation 2010 Unauthorized copying and distribution is a violation of law.

1 Safety Precautions



It is describing to be always looked after for the accident prevention at the time of the repair works and the safety ensuring of the product after work as follows.

The precautions listed below must be followed in order to prevent accidents during repair and ensure the safety of the product after repair.

■ The following labels describe the degree of danger and damage that might result through non-compliance with these precautions.

	Danger	This section warns of the urgent danger of death or serious injury.
	Warning	This section warns of the risk of death or serious injury.
	Caution	This section warns of the risk of injury or damage to property.





■ The following labels describe the types of rules that need to be followed.
(These labels are examples.)

	This label shows a "reminder" action to be paid attention to.
	This label shows a "prohibited" action.
	This label shows a "compulsory" action to be followed without fail.

Danger

	Be careful of electrical shocks caused by the high-voltage section of the IH circuit when the power is turned on.
High voltage	The high-voltage section of the IH circuit includes a heat sink and heating coil terminal on the control board.

Warning

<p>After repair, return wiring to its original condition.</p> <p> Rotary parts or part extremities that contact lead may cause failure, electrical shock, or fire.</p>	<p>Unplug before repair.</p> <p> Make sure to unplug before disassembly, parts replacement, and assembly. Otherwise, electrical shock or injury may occur.</p> <p>Unplug</p>
<p>Use a designated part</p> <p> Make sure to use a designated part when the part is marked in circuit diagrams and parts lists. Otherwise, smoke, fire, or failure may occur.</p>	<p>Wait until the rotary part has stopped completely.</p> <p> You may injure your hands even when the part is rotating slowly.</p> <p>Do not touch</p>

Caution

	Wear gloves for disassembly, replacement and assembly.
	Make sure to wear gloves in order to prevent injuries by metal edges and electric shock when the power is turned on.

2 Specifications

2.1. SR-W18FGSWUA

		SR-W18FGSWUA
Power Source		AC220V
Power Consumption	Cooking	600W
	Warming	45W
Cooking Capacity		2cups-10cups (0.36L-1.8L)
Warming Capacity		2cups-10cups (0.36L-1.8L)
Center Thermostat Working Temperature		134°C
Cooked Rice Warming Temperature		Above 80°C an hour after warming starts.
Thermal fuse		119°C 10A
Dimensions		(Width) 308mm (Depth) 263mm (Height) 255mm
Weight		2.2kg
Cord		Approx. 1.0m
Accessories		Measuring cup, Steam basket

3 Location of Controls and Components

KEEP WARM TYPE

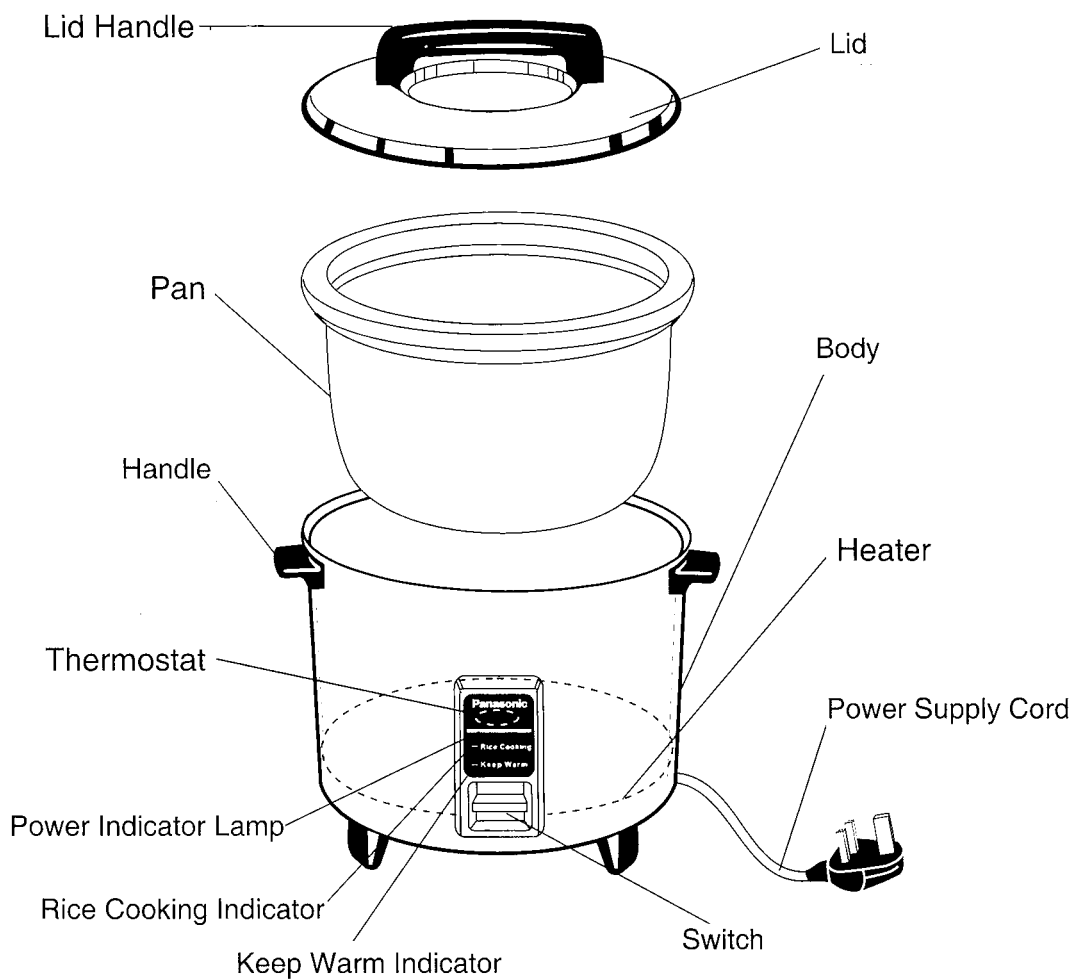

Accessories



Measuring cup (approx. 180 ml)

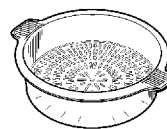

Steam Basket

4 Troubleshooting Guide

رفع اشكال / حل المشكلة / 故障排除 / TROUBLESHOOTING

Description 故障描述	Rice cooking problems 煮飯問題					Keep warm problem 保溫問題		Unusual noise 異常噪音	No electric power 無電					
	Rice is hard 米飯太硬	Rice is half cooked 米飯半生半熟	Rice is too soft 米飯太軟	Water is overflowing 水溢出	Rice on the bottom is scorched 底部仍未煮熟	Rice smells bad 米飯有臭味	Rice changes color 米飯變色			Rice is too dry 米飯太幹				
Possible Causes 可能的原因	Improper proportion of rice and water 米和水的比例不對	Rinsed rice but not clear 米經過清洗，但是不透徹	Scratches on the inner side of the Pan 鍋內側有刮傷	Rice cooked with oil 煮熟的米飯帶油	Rice is not mixed after done 完成之後未混合米飯	Warm rice more than 5 hours 米飯保溫超過5個小時	Uncommon objects stuck on the inner side of the Pan 異物粘在鍋內側	Uncommon objects stuck between the outer side of the Pan and the Heater 異物粘在鍋外側和加熱器之間	Warm the leftover cooked rice 給剩下的米飯保溫	Not closing the Lid firmly 鍋蓋沒蓋緊	Wash the inner side of the Pan but not clean 洗刷鍋內側，但是不乾淨	Unplug or switch off 拔出插頭或關閉電源	Noise occurs if there is water between the outer side of the Pan and the Heater. This may cause damage to the Heater. 如果鍋外側和加熱器之間有水，則會出現噪音。 這可能會導致加熱器受損。	Unplug and check the circuit breaker. If there is no problem at the breaker, take the Automatic Rice Cooker to the nearest service centre 拔出插頭，然後檢查斷路器。 如果斷路器沒有問題，請將自動電飯煲送到離您最近的服務中心。

مشاكل غير متكررة الصورة، غير المتكررة	مشاكل متكررة الصورة، المتكررة	مشاكلات يخبث الأرز المشاكل لطبخ الأرز		مشاكلات گرم نگه داشتن مشاكلة الاحتفاظ بالحرارة				حالتی تشر / التوضيف سبب های امکان الأسباب الممكنة	
		الأرز يخبث كثيراً الأرز يخبث كثيراً الأرز يخبث كثيراً الأرز يخبث كثيراً	الأرز يخبث كثيراً الأرز يخبث كثيراً الأرز يخبث كثيراً الأرز يخبث كثيراً	الأرز يخبث كثيراً الأرز يخبث كثيراً الأرز يخبث كثيراً الأرز يخبث كثيراً	الأرز يخبث كثيراً الأرز يخبث كثيراً الأرز يخبث كثيراً الأرز يخبث كثيراً	الأرز يخبث كثيراً الأرز يخبث كثيراً الأرز يخبث كثيراً الأرز يخبث كثيراً	الأرز يخبث كثيراً الأرز يخبث كثيراً الأرز يخبث كثيراً الأرز يخبث كثيراً		الأرز يخبث كثيراً الأرز يخبث كثيراً الأرز يخبث كثيراً الأرز يخبث كثيراً
در صورت موجودی آب در سطح بیرونی ماهی تابه، آواز برمی خیزد. این باعث گرمی گرم کن می شود.	يجتنب الصدمة إذا كان هناك ماء بين الجانب الداخلي للمقلاة والمقلاة. قد يسبب الضرر للمقلاة.	برق را قطع کرده و مدار شکن را بررسی کنید و هرگاه اگر مشکلی پیدا نکرد پس باید آنرا به مرکز خدمات ببرید.	انزع القابس الكهربائي و اقصن قاطع الدور الكهربائي. إذا سلك هناك مشكلة في القاطع، اذهب بطبقة الأرز الكهربائية إلى مركز الخدمة أقرب.	استفاده نادرست برنج و آب جزء غیر صحیح من الأرز و الماء برنج را با آب نشویند. الأرز المشطف و كان غير صائب خر الشیده شدن سطح درونی ماهی تابه الخدوش في الجانب الداخلي للمقلاة برنج با روغن پخته میشود تم طبخ الأرز بالزيت	برنج پس از پخته شدن مخلوط نمی شود. لم يتم تقطير الأرز بعد اكتماله برنج را تا 5 ساعت گرم کنید. الأرز الحار اكثر من 5 ساعات	اشیای بیرونی به ماهی تابه چسبیده شده است. تمثلت المواد غير طبيعية في الجانب الداخلي للمقلاة اشیا بیرونی به ماهی تابه چسبیده شده بین سطح بیرونی ماهی تابه و گرم کن تمثلت المواد غير طبيعية بین	پس مانده برنج را باید گرم کرد. الجانب الداخلي للمقلاة و المقلاة درست جاییا تکرار می شود. لا يعلق المقلاة بياك	درون ماهی تابه را شسته اما پاک نکند. غسل الجانب الداخلي للمقلاة و ليس تنظيفا خاموس نموده از برقی قطع کنید. نزع القابس الكهربائي أو الإطفاء	سبب های امکان الأسباب الممكنة

5 Schematic Diagram

5.1. SR-W18FGSWUA

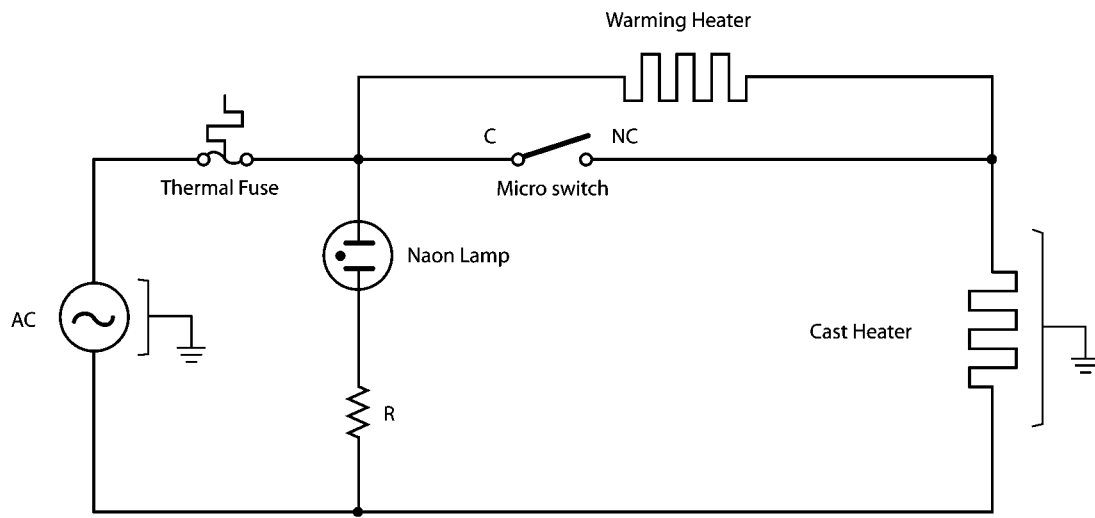

6 Exploded View and Replacement Parts List

6.1. Exploded View

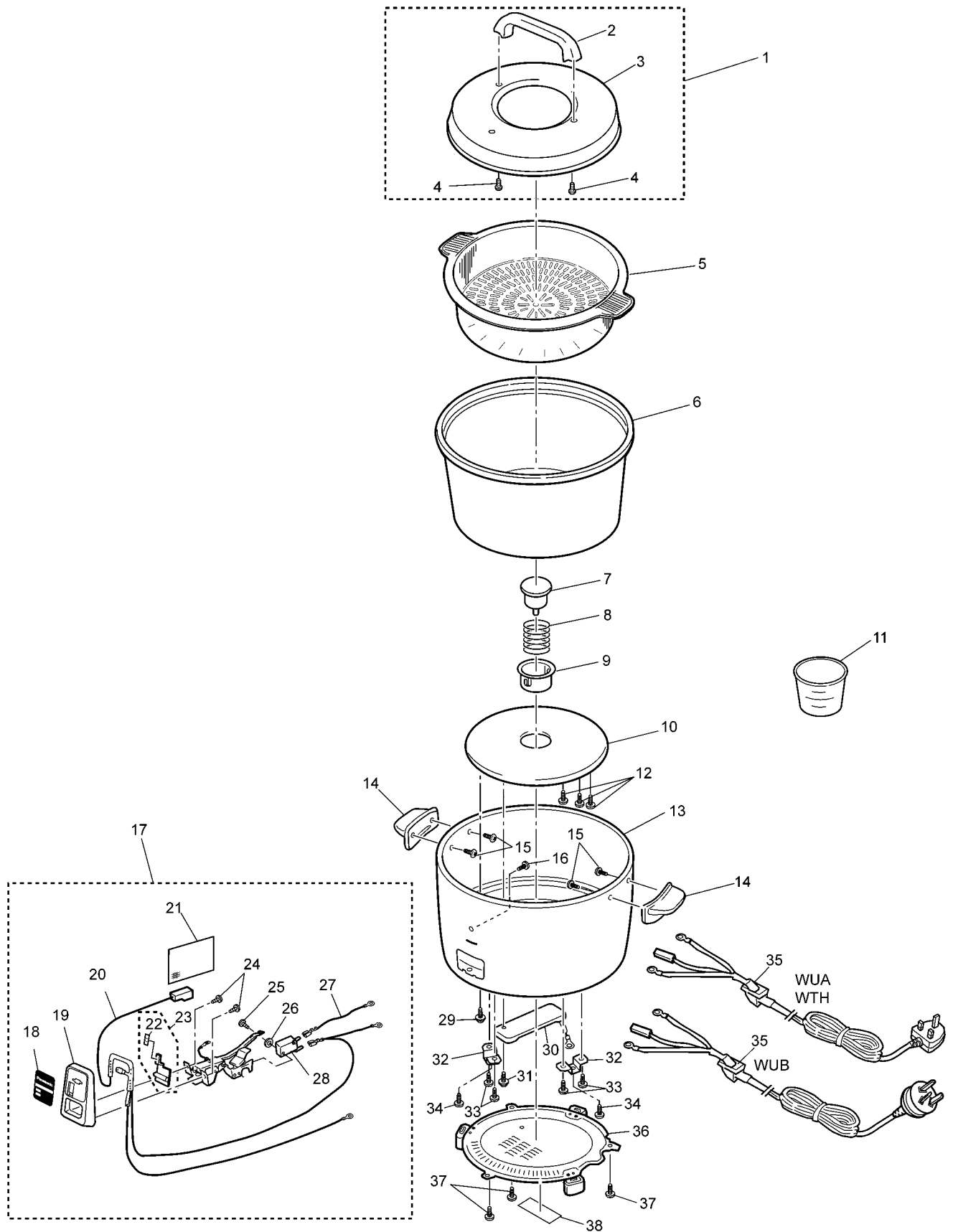

6.2. Replacement Parts List

Notes: Important safety notice

- Components identified by Δ mark have special characteristics important for safety.
- When replacing any of these components use only manufacturer's specified parts.
- Order the INDIA mark's parts from PHAI (INDIA), the JAPAN mark's parts from KABU.

MODEL No. SR-W18FGSWUA

Safety	Ref. No.	Part No.	Supplier	Part Name & Description	Pcs/Set	Remarks
					WUA	
< PARTS LIST >						
	1	AQB01D104H0U	INDIA	Outer lid comp.	1	
	2	AQB10D100-H0	INDIA	Lid knob	1	
	3	AQB01D104	INDIA	Outer lid	1	
	4	XTN4+10BWW	JAPAN	Screw (for lid knob)	2	
	5	AQK25A195-C0	INDIA	Steam basket	1	
	6	AQE50A190	INDIA	Pan	1	
Δ	7	ASR300U254P	JAPAN	Center thermostat	1	
	8	ASR312-244-H	JAPAN	Outer spring	1	
	9	ASR310-607-T	JAPAN	Outer case	1	
Δ	10	AQL20Y52200U	INDIA	Cast heater	1	Sheathed heater. 220V
	11	AQR00D100	INDIA	Measuring cup	1	180ml
	12	XYN4+C7FNS	JAPAN	Screw (for internal wiring)	3	
	13	AQE10D100W1U	INDIA	Body	1	
	14	AQE30D100-H0	INDIA	Handle	2	
	15	XTN4+8BFY	JAPAN	Screw (for handle)	4	
	16	XTN4+8BFY	JAPAN	Screw (for switch)	1	
Δ	17	AQN00Y522W1U	INDIA	Switch comp.	1	
	18	AQN20Y105	INDIA	Decorative panel	1	
	19	AQN10D100-W1	INDIA	Switch panel	1	
Δ	20	AQN35Y522	INDIA	Lamp with thermal fuse	1	109 \AA . 10A
	21	AQQ91Y522	INDIA	Glass tape B	1	
	22	AQN32D100	INDIA	Indicator sheet	1	
	23	AQN31D10000U	INDIA	Push button	1	
	24	XTN3+10BFJ	JAPAN	Screw (for switch lever)	2	
	25	XYN3+C14FNS	JAPAN	Screw (for micro switch)	1	
	26	AQN02D100	INDIA	Fiver washer (for micro switch)	1	
Δ	27	AQN44D209	INDIA	Lead wire	1	
Δ	28	AQN01D100	INDIA	Micro switch	1	
	29	XYN5+C10FNS	JAPAN	Screw (for cast heater)	1	
Δ	30	AQL70D20900U	INDIA	Warming heater	1	
	31	XYN5+C10FNS	JAPAN	Screw (for warming heater)	1	
	32	ARQ18Y522	INDIA	Earth plate	2	
	33	XTN4+6FFJ	JAPAN	Screw (earth plate)	4	
	34	XYC4+EF8FJ	JAPAN	Screw (earth lead wire)	2	
Δ	35	AQQ00Y52200U	INDIA	Power cord ass'y	1	AC220V. W/S-3 Plug
	36	AQH20D100W1U	INDIA	Bottom plate	1	
	37	XTN4+8BFJ	JAPAN	Screw (for bottom plate)	3	
Δ	38	AQY50Y524	INDIA	Name plate	1	
< PACKING SPECIFICATIONS >						
		AQZ02Y524	INDIA	Outer carton	1	
		AQZ20D100	INDIA	Lower pad A	1	
		AQZ21D100	INDIA	Lower pad B	1	
		AQZ25D100	INDIA	Upper pad	2	
		AQZ30D100	INDIA	Cord protector	1	
Δ		AQY00Y524	INDIA	Operating instructions	1	
		AQZ03D100	INDIA	Protecting sheet	4	
		AQZ31D100	INDIA	Packing paper (for lid)	1	
		AQZ33L102	INDIA	Rust proof paper	1	