

Service Manual

Hand Blender

Model No. **MX-SS1BTN**

Model No. **MX-GS1WTN**

Chassis

Product Color B:Black, W:White

Destination: UAE, Kuwait, Oman, Hong Kong,
Saudi Arabia

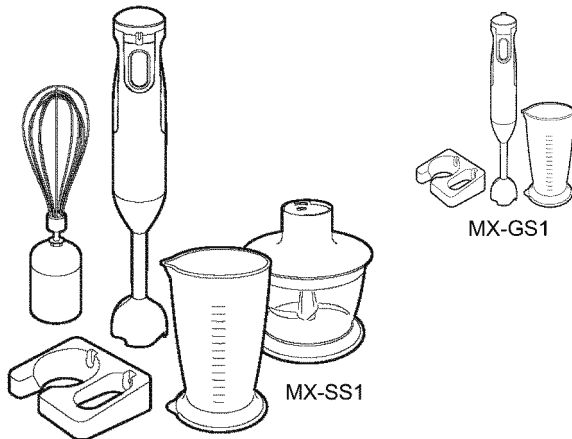

⚠ WARNING

This service information is designed for experienced repair technicians only and is not designed for use by the general public. It does not contain warnings or cautions to advise non-technical individuals of potential dangers in attempting to service a product. Products powered by electricity should be serviced or repaired only by experienced professional technicians. Any attempt to service or repair the product or products dealt with in this service information by anyone else could result in serious injury or death.

IMPORTANT SAFETY NOTICE

There are special components used in this equipment which are important for safety. These parts are marked by **⚠** in the Schematic Diagrams, Circuit Board Diagrams, Exploded Views and Replacement Parts List. It is essential that these critical parts should be replaced with manufacturer's specified parts to prevent shock, fire or other hazards. Do not modify the original design without permission of manufacturer.

TABLE OF CONTENTS

	PAGE	PAGE
1 Safety Precautions -----	2	
2 Specifications -----	3	
3 Installation Instructions -----	4	
3.1. Parts Names and Handling Instructions-----	4	
4 Operating Instructions -----	6	
4.1. How to Use-----	6	
4.2. How to Clean-----	9	
5 Troubleshooting Guide -----	10	
6 Schematic Diagram -----	11	
6.1. Model MX-SS1-----	11	
6.2. Model MX-GS1-----	11	
7 Exploded View and Replacement Parts List -----	12	
7.1. Model MX-SS1, MX-GS1-----	12	



Panasonic

© Panasonic Corporation 2017 Unauthorized copying and distribution is a violation of law.



1 Safety Precautions

The precautions listed below must be followed in order to prevent accidents during repair and ensure the safety of the product after repair.



■ The following labels describe the degree of danger and damage that might result through non-compliance with these precautions.

	Danger	This section warns of the urgent danger of death or serious injury.
	Warning	This section warns of the risk of death or serious injury.
	Caution	This section warns of the risk of injury or damage to property.

■ The following labels describe the types of rules that need to be followed.
(These labels are examples.)

	This label shows a "reminder" action to be paid attention to.
	This label shows a "prohibited" action.
	This label shows a "compulsory" action to be followed without fail.

Warning

<p>After repair, return wiring to its original condition.</p> <p> Rotary parts or part extremities that contact lead may cause failure, electrical shock, or fire.</p>	<p>Before repair.</p> <div style="border: 1px solid black; padding: 2px; display: inline-block;"> <p>CUT A.C. POWER LINE</p> </div> <p>Make sure to cut off the power line before disassembly, parts replacement, and assembly. Otherwise, electrical shock or injury may occur.</p>
<p>Use a designated part</p> <p> Make sure to use a designated part when the part is marked in circuit diagrams and parts lists. Otherwise, smoke, fire, or failure may occur.</p>	<p>Wait until the rotary part has stopped completely.</p> <p> You may injure your hands even when the part is rotating slowly.</p> <p>Do not touch</p>

Caution

<p> Wear gloves for disassembly, replacement and assembly.</p> <p>Make sure to wear gloves in order to prevent injuries by metal edges and electric shock when the power is turned on.</p>
--

2 Specifications

>> Specifications MX-SS1 / MX-GS1

		MX-SS1	MX-GS1
Power supply		220 - 240 V ~ 50 - 60 Hz	
Power consumption		600 W	
Speed control		Variable speed control	—
Operation rating	Blender	2 consecutive cycles of 1 min. ON, then 3 min. OFF	
	Chopper	2 consecutive cycles of 1 min. ON, then 3 min. OFF	—
	Whisk	2 consecutive cycles of 2 min. ON, then 3 min. OFF	—
Dimensions (Motor housing + attachment) (W × D × H) (approx.)	Blender	6.4 × 7.0 × 39.7 cm	6.4 × 7.0 × 39.7 cm
	Chopper	14.7 × 14.7 × 36.9 cm	—
	Whisk	6.0 × 6.8 × 45.7 cm	—
Mass (Motor housing + attachment) (approx.)	Blender	1.0 kg	1.0 kg
	Chopper	1.2 kg	—
	Whisk	1.0 kg	—
Length of the power cord (approx.)		1.3 m	

>> Fixing the wall bracket MX-SS1 / MX-GS1

QQFix the wall bracket on the firm wall properly. If it is fix on fragile surface such as sheetrocks, it may be loose up easily and cause the blender to fall or damage to the wall.

1. Drill two holes (depth of plastic tube's length) in the wall.
(Refer to illustration for dimension.)
2. Hammer two plastic tubes into the holes.
3. Secure the wall bracket on the wall with two screws.

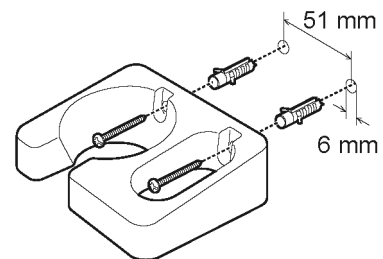

3 Installation Instructions

3.1. Parts Names and Handling Instructions

Parts Names and Handling Instructions

- The illustrations inside mainly show model MX-SS1.
- Wash all the detachable parts before using the appliance for the first time or when you have not used it for a while. (P. EN16)

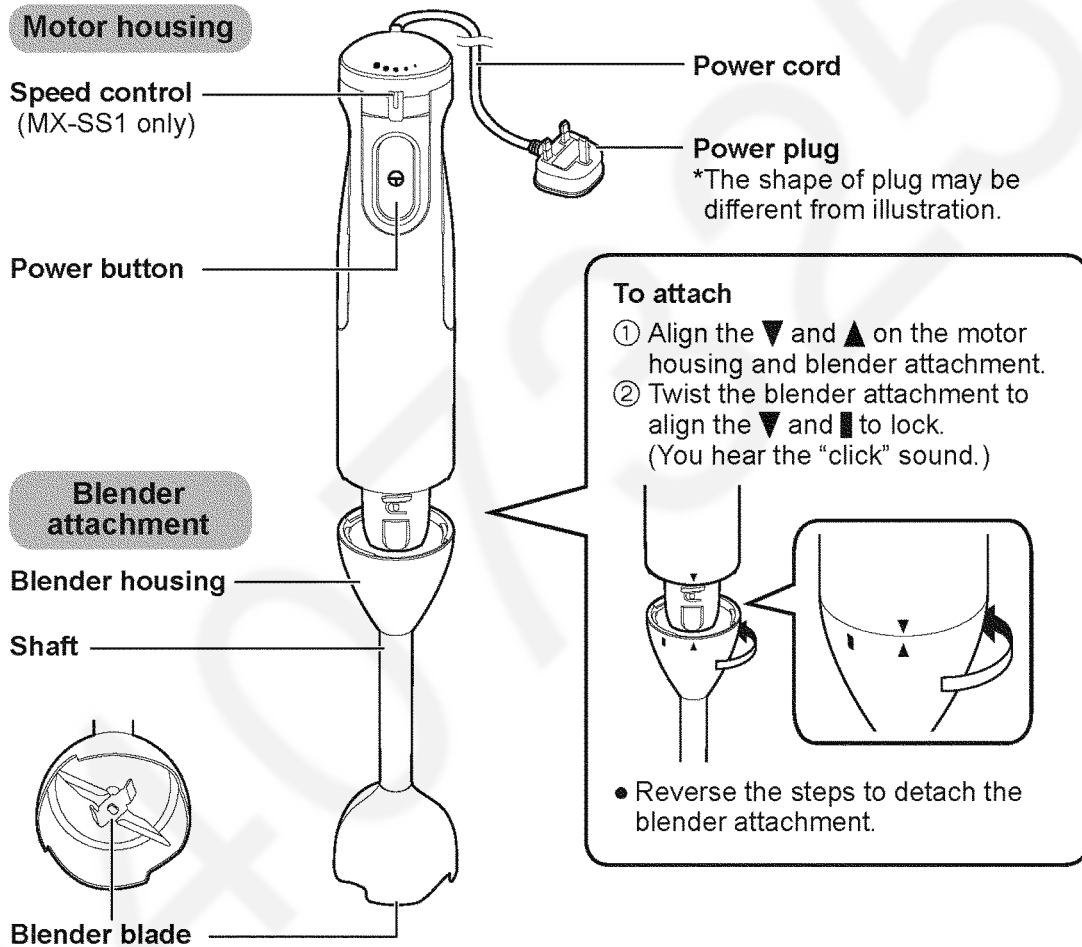

To attach

- ① Align the ▼ and ▲ on the motor housing and blender attachment.
- ② Twist the blender attachment to align the ▼ and ■ to lock. (You hear the “click” sound.)

- Reverse the steps to detach the blender attachment.

Accessories

Beaker

Base
(Also use as lid.)

Wall bracket

- To fix the wall bracket, refer to page EN19.

Chopper attachment (MX-SS1 only)

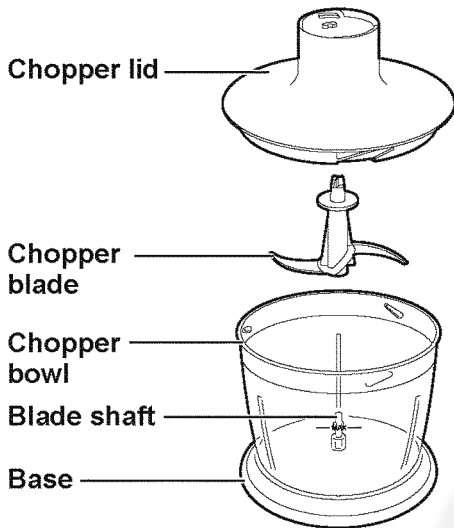

To attach

- ① Insert the chopper blade into the blade shaft.
- ② Align the groove of the chopper lid and convex of the chopper bowl, then turn the chopper lid clockwise to close it.
- ③ Align the ▼ and ▲ on the motor housing and chopper lid.
- ④ Twist the motor housing to align the ▼ and ■ to lock.
(You hear the "click" sound.)

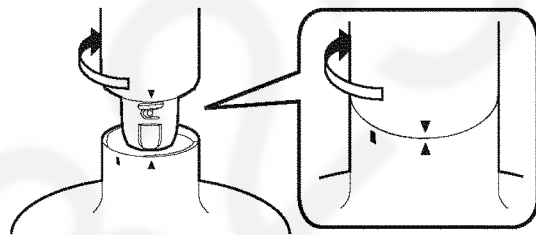

- Reverse the steps to detach the chopper attachment.

Whisk attachment (MX-SS1 only)

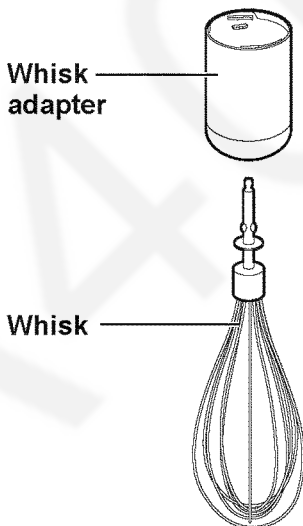

To attach

- ① Insert the whisk into the whisk adapter.
(You hear the "click" sound.)
- ② Align the ▼ and ▲ on the motor housing and whisk attachment.
- ③ Turn the whisk attachment to align the ▼ and ■ to lock.
(You hear the "click" sound.)

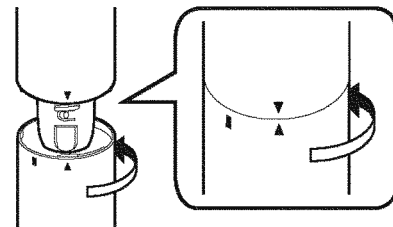

- Reverse the steps to detach the whisk attachment.

4 Operating Instructions

4.1. How to Use

How to Use Using the blender attachment

- Using blender attachment for sauces, dips, soup, fruit, milk shakes, cooked vegetables baby food or making mayonnaise, etc.

Note

- Do not use the hard ingredients as they may damage the blade.
- You can use the other container such as deep bowl instead of the beaker.
- Avoid scratching the pan or bowl when blending ingredients by hitting.
- Do not exceed the quantity of ingredients higher than connection of the blender housing and shaft.
- Do not operate the blender continuously for more than 1 minute. Rest over 3 minutes after 1 minute operation at two consecutive cycles.
- Do not use the blender when the saucepan is on the heat source.
- Do not insert or remove the appliance from the bowl during the power button is pressed.

Prohibition Ingredients

- Hard ingredients such as:
 - coffee beans
 - fish
 - meat
 - frozen food
 - ice cube
 - soy beans
 - turmeric etc.
- Sticky ingredients
- Hard dough such as bread dough.

Preparations

- Pre-cut ingredients into approx. 2 cm cubes or sticks.

- 1** Attach the blender attachment to the motor housing. Then plug in. (P. EN8)

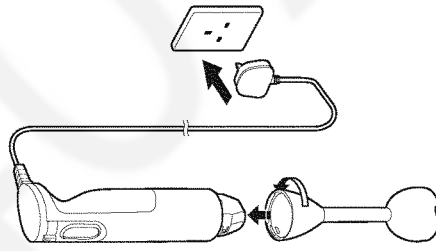

- Make sure blender attachment is attached firmly.

- 2** Insert the blender into the beaker and hold the power button down to start.

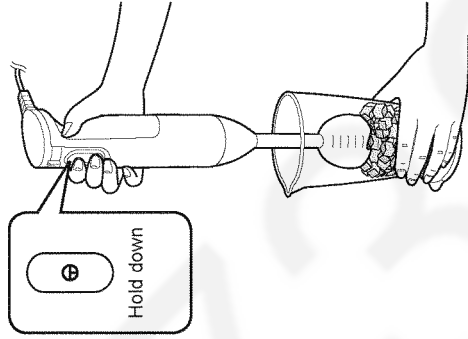

- Adjust speed by turning the speed control. (MX-SS1 only)
- The blender lightly touch the bottom of beaker and start blending.
- While operating, hold the beaker steadily.

- 3** When blending is complete, release power button before removing the appliance from the mixture.

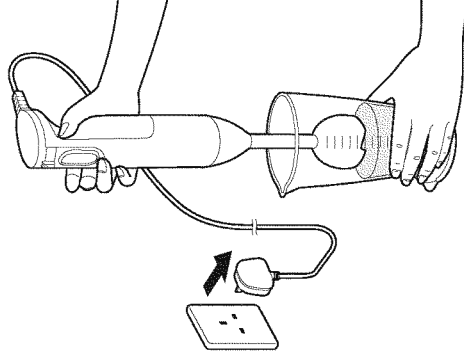

- Unplug immediately after use and remove the blender attachment.

How to Use Using the chopper attachment (MX-SS1 only)

- Using chopper attachment to chop food such as vegetables, nuts, cheese, herbs, crackers, bread and meat.

Note

- Do not use the hard ingredients as they may damage the blade.
- Do not exceed the quantity of ingredients higher than MAX line.
- Do not operate the chopper continuously for more than 1 minute. Rest over 3 minutes after 1 minute operation at two consecutive cycles.

Prohibition Ingredients

- Hard ingredients such as:
 - coffee beans
 - frozen food
 - ice cube
 - soy beans
 - turmeric etc.
- Sticky ingredients
- Hard dough such as bread dough.

Preparations

- Pre-cut ingredients into approx. 2 cm cubes or sticks.
- Un-shell nuts.
- Remove bones, tendons and gristle from meat.

- 1** Insert the chopper blade into the chopper bowl and place cut ingredients into the chopper bowl.

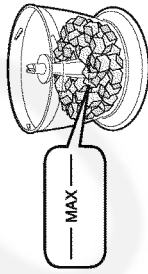

- 2** Close the chopper lid and attach the motor housing onto the chopper attachment. Then plug in. (P. EN9)

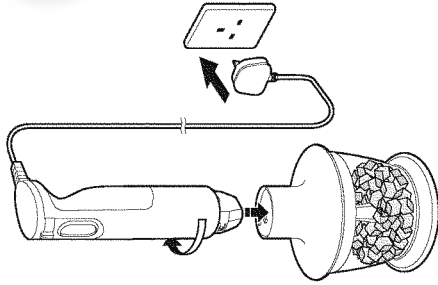

- Make sure chopper attachment is attached firmly.

- 3** Hold the power button down to start.

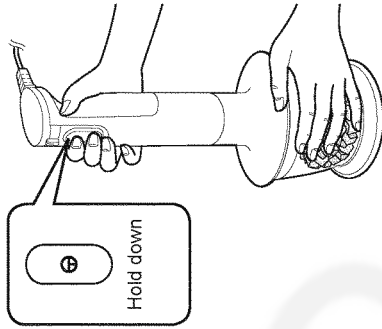

- Adjust speed by turning the speed control. (MX-SS1 only)
- While operating, hold the chopper attachment steadily.
- During the operation, do not open the chopper lid.

- 4** When chopping is complete, release the power button before removing the motor housing.

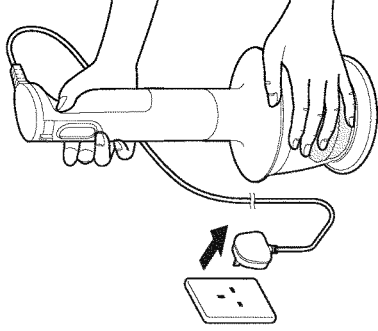

- Unplug immediately after use and remove the motor housing.**

Reference for quantity and time

Ingredients	Max. quantity	Operating time (approx.)	Speed (MX-SS1 only)
Onion	200 g	10 sec.	● ● ● ● ●
Carrot		10–30 sec.	● ● ● ● ●
Meat		30 sec.	● ● ● ● ●
Parmesan cheese		20 sec.	● ● ● ● ●
Nuts		30 sec.	● ● ● ● ●
Dry bread	80 g	30 sec.	● ● ● ● ●

How to Use Using the whisk attachment (MX-SS1 only)

- Using whisk attachment to whip cream or beat egg whites.

Note

- Use the deeper bowl to avoid splashing ingredients.
- Avoid scratching the pan or bowl when blending ingredients by hitting.
- Do not operate the whisk continuously for more than 2 minutes. Rest over 3 minutes after 2 minutes operation at two consecutive cycles.
- When whip eggs, do not exceed 4 eggs whites.

Prohibition Ingredients

- Hard dough such as bread dough.

Preparations

- Chilled cream before whipping it.

- 1** Attach the whisk attachment into the motor housing. Then plug in. (P. EN9)

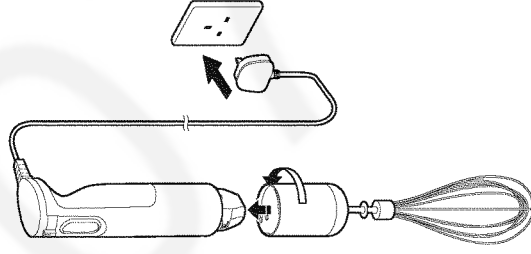

- Make sure the whisk attachment is attached firmly.

- 2** Insert the whisk into the bowl and hold the power button down to start.

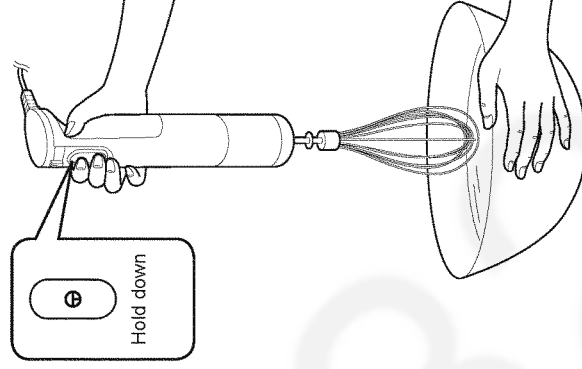

- Hold the whisk vertically when whipping ingredients.
- Adjust speed by turning the speed control. (MX-SS1 only)
- The whisk lightly touch the bottom of bowl and start whisking.
- While operating, hold the bowl steadily.
- When the ingredients are of small quantity, whisk well by tilting the bowl.

- 3** When whisking is complete, release the power button before removing the whisk.

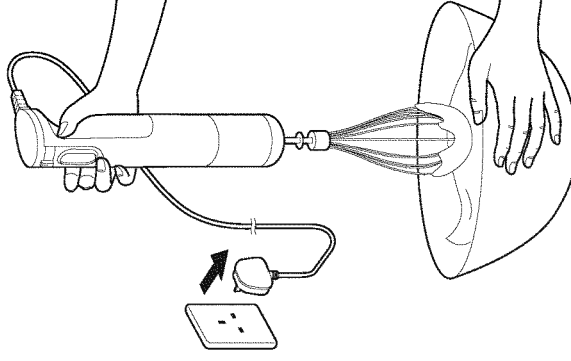

- Unplug immediately after use and remove the whisk attachment.

4.2. How to Clean

How to Clean

- Clean the appliance after every use.
- Unplug before cleaning.

Note

- Do not use benzine, thinner, alcohol, bleach, polishing powder, metal brush or nylon brush, otherwise the surface will be damaged.
- Do not wash the motor housing, chopper lid and whisk adapter in a dishwasher.
- Do not clean the appliance with pointed object such as a toothpick or pin.

Motor housing/Wall bracket

Wipe with a well-wrung cloth.



Beaker*

Wash with diluted dish soap (neutral) and a soft sponge.

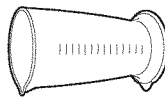

Blender attachment*

Fill the beaker with water and operate the blender approx. 5 seconds in the beaker to remove residue. Change the water and repeat it few times.

Then wash with diluted dish soap (neutral) and a brush with handle.

Note

Care shall be taken when handling and cleaning the blades.

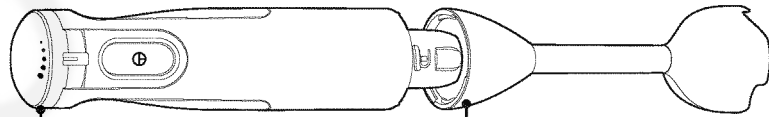

*Dishwasher safe

Chopper lid (MX-SS1 only)

Wash with diluted dish soap (neutral) and a soft sponge.

Note

Do not soak in water.

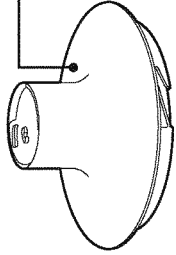

Chopper blade* (MX-SS1 only)

Wash with diluted dish soap (neutral) and a brush with handle.

Note

Care shall be taken when handling and cleaning the blades.

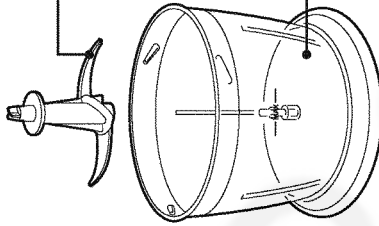

Chopper bowl* (MX-SS1 only)

Wash with diluted dish soap (neutral) and a soft sponge.

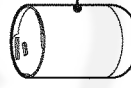

Whisk adapter (MX-SS1 only)

Wipe with a well-wrung cloth.

Whisk* (MX-SS1 only)

Wash with diluted dish soap (neutral) and a soft sponge.

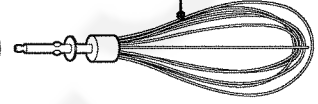

*Dishwasher safe

5 Troubleshooting Guide

Troubleshooting

Problem	Cause and Action
The appliance does not turn on.	<ul style="list-style-type: none">• The power plug is not in the outlet. → Plug in firmly.
The ingredients are not blending.	<ul style="list-style-type: none">• The quantity of the ingredients are too much. → Reduce the quantity of the ingredients.• The ingredients are too large. → Cut them into smaller pieces.• Using hard ingredients. → Remove the hard ingredients.• Using improper speed. (MX-SS1 only) → Adjust speed by turning the speed control.• The blade may be damaged. → Contact the service centre.
Abnormal noise occur.	<ul style="list-style-type: none">• Using hard ingredients. → Remove the hard ingredients.• The motor housing may not be securely attached. → Re-attach the motor housing. (P. EN8, EN9)• The chopper lid is not close firmly. (P. EN9) (MX-SS1 only) → Re-close the chopper lid.
Abnormal vibration occur.	<ul style="list-style-type: none">• The quantity of the ingredients are too much. → Reduce the quantity of the ingredients.• The ingredients are too large. → Cut them into smaller pieces.• Using hard ingredients. → Remove the hard ingredients.
The attachment is not able to attach.	<ul style="list-style-type: none">• The attachment is not attached properly. → Re-attach it. (P. EN8, EN9) If it is still not able to be attached, contact service centre.

6 Schematic Diagram

6.1. Model MX-SS1

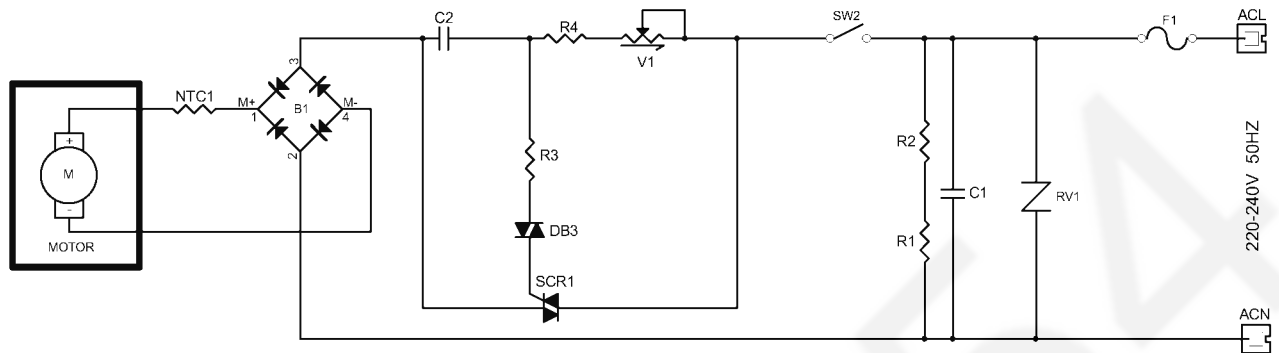

6.2. Model MX-GS1

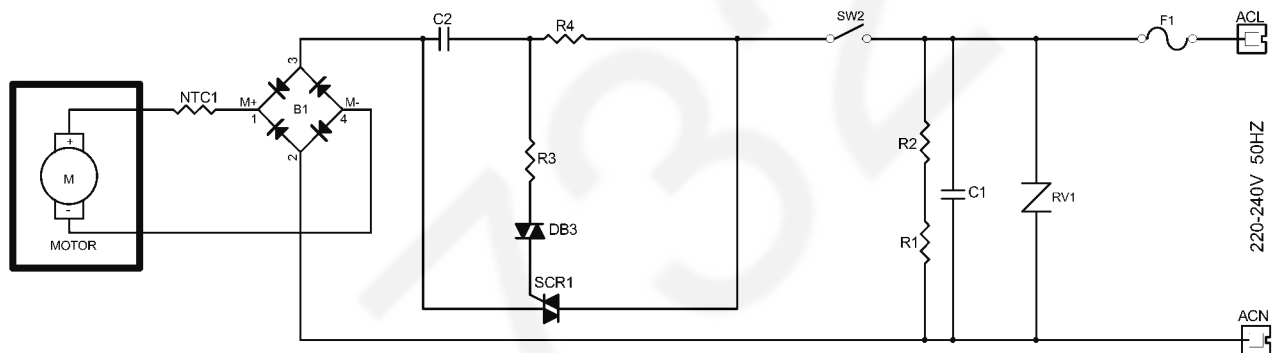

7 Exploded View and Replacement Parts List

7.1. Model MX-SS1, MX-GS1

7.1.1. Part Location <Model MX-SS1, MX-GS1>

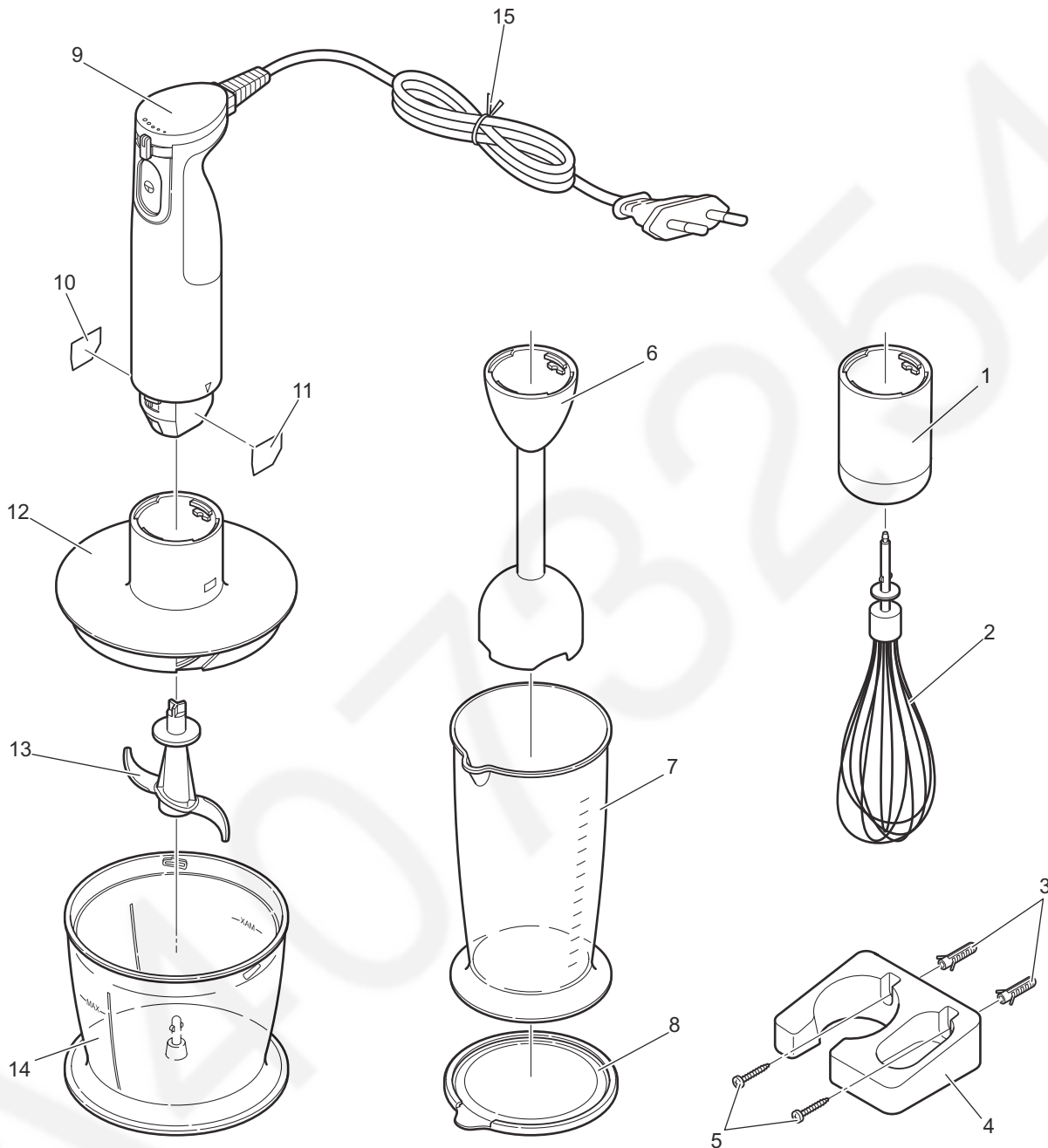

7.1.2. Replacement Parts List <Model MX-SS1, MX-GS1>

Notes: Important safety notice

- Components identified by △ mark have special characteristics important for safety.
- " When replacing any of these components use only manufacturer's specified parts."
- Please order 'Individual box' ten by a unit.

Safety	Ref. No.	Part No.	Part Name & Description	Pcs/Set		Remarks
				SS1BTN	GS1WTN	
<PARTS LIST>						
	1	AMA35-236-K0	Wisk gear unit	1		
	2	AMA34-236	Wisk wire unit	1		
	3	AMJ15-236	Anchor plug	2	2	
	4	AMB02-236-K0	Wall rack S	1		
	4	AMB02-237-W0	Wall rack G		1	
	5	XTN3D28AFJ	Screw A	2	2	
△	6	AMA18-236K0U	Blender S	1		
△	6	AMA18-237W0U	Blender G		1	
	7	AMD02-236	Beaker	1	1	
	8	AMD17-236	Beaker rubber leg	1	1	
△	9	AMA02Y236-K0	Body unit S	1		Black. 220V-240V. BS1363_Type G plug
△	9	AMA02Y237-W0	Body unit G		1	White. 220V-240V. BS1363_Type G plug
△	10	AMY21-236	Rating plate S	1		
△	10	AMY21-237	Rating plate G		1	
△	11	AMY22-236	Rating plate S	1		
△	11	AMY22-237	Rating plate S		1	
	12	AMA05-236-K0	Chopper cover unit	1		
△	13	AMA39-236	Chopper cutter unit	1		
	14	AMD00-236	Container unit	1		
	15	AMQ09-236	Cord band	1	1	
<PACKING SPECIFICATIONS>						
		AMZ01J236	Inner case S	1		
		AMZ01J237	Inner case G		1	
		AMY20J236	POS label S	1		
		AMY20J237	POS label G		1	
		AMZ05-236	Cushion L	1		
		AMZ07-236	Cushion R	1		
		AMZ08-236	Cushion T	1		
		AMZ06-237	Cushion R		1	
		AMZ07-237	Cushion T		1	
		AMZ22-237	Cushion A		1	
		AMZ23-237	Cushion B		1	
		AMZ24-237	Cushion C		1	
		AMZ25-237	Cushion D		1	
△		AMZ50J236	Operating instructions	1		

7.1.3. Packing Instruction <Model MX-SS1>

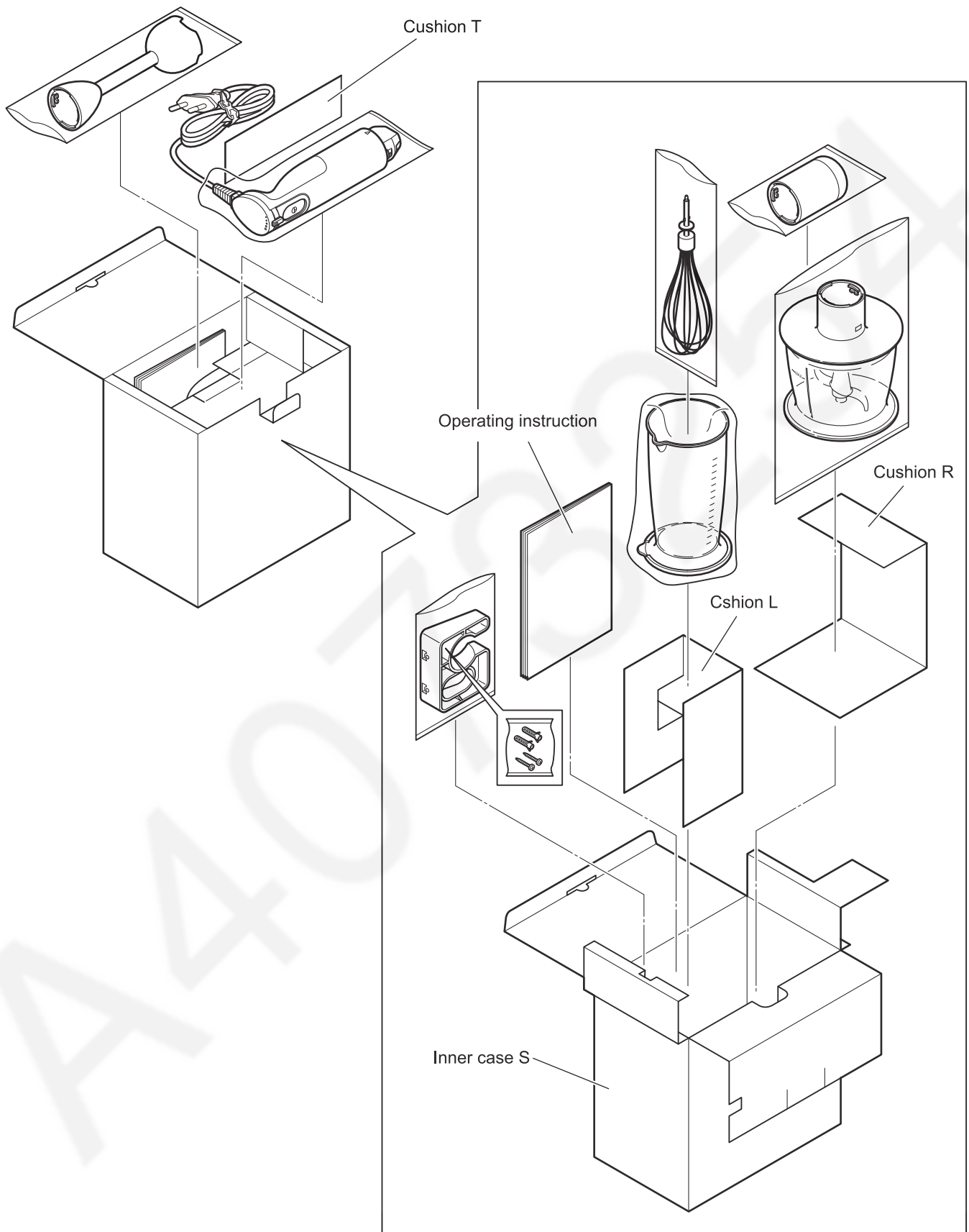

7.1.4. Packing Instruction <Model MX-GS1>

