

Service Manual

Hand Blender

Model No. **MX-S401STN/STZ**
MX-S301KTN/KTZ
MX-S101WTN/WTZ

Chassis

Product Color S: Silver, K: Black, W: White

Destination: TN: Iran, Iraq, Egypt, Jordan, Pakistan, South Africa

TZ: Sudan, Afghanistan, Nigeria, UAE, Saudi Arabia, Kuwait, Oman

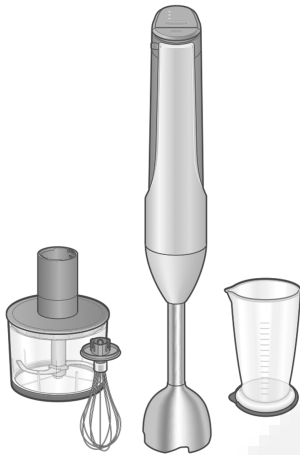

⚠ WARNING

This service information is designed for experienced repair technicians only and is not designed for use by the general public. It does not contain warnings or cautions to advise non-technical individuals of potential dangers in attempting to service a product. Products powered by electricity should be serviced or repaired only by experienced professional technicians. Any attempt to service or repair the product or products dealt with in this service information by anyone else could result in serious injury or death.

IMPORTANT SAFETY NOTICE

There are special components used in this equipment which are important for safety. These parts are marked by ⚠ in the Schematic Diagrams, Circuit Board Diagrams, Exploded Views and Replacement Parts List. It is essential that these critical parts should be replaced with manufacturer's specified parts to prevent shock, fire or other hazards. Do not modify the original design without permission of manufacturer.

TABLE OF CONTENTS

	PAGE
1 Safety Precautions	2
2 Specifications	3
2.1. Spec. MX-S401/301.....	3
2.2. Spec. MX-S101	3
3 Part Names and Instructions	4
4 Preparations	6
5 Prohibited Ingredients & Operating Instructions	7
6 Schematic Diagram	12
6.1. Model MX-S401.....	12
6.2. Model MX-S301.....	13
6.3. Model MX-S101.....	13
7 Exploded View and Replacement Parts List	14
7.1. Replacement Parts List	15



Panasonic

© Panasonic Corporation 2017 Unauthorized copying and distribution is a violation of law.



1 Safety Precautions

The precautions listed below must be followed in order to prevent accidents during repair and ensure the safety of the product after repair.



■ The following labels describe the degree of danger and damage that might result through non-compliance with these precautions.

	Danger	This section warns of the urgent danger of death or serious injury.
	Warning	This section warns of the risk of death or serious injury.
	Caution	This section warns of the risk of injury or damage to property.

■ The following labels describe the types of rules that need to be followed.
(These labels are examples.)

	This label shows a "reminder" action to be paid attention to.
	This label shows a "prohibited" action.
	This label shows a "compulsory" action to be followed without fail.

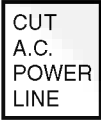
Warning



<p>After repair, return wiring to its original condition.</p> <p> Rotary parts or part extremities that contact lead may cause failure, electrical shock, or fire.</p>	<p>Before repair.</p> <p> Make sure to cut off the power line before disassembly, parts replacement, and assembly. Otherwise, electrical shock or injury may occur.</p>
<p>Use a designated part</p> <p> Make sure to use a designated part when the part is marked in circuit diagrams and parts lists. Otherwise, smoke, fire, or failure may occur.</p>	<p>Wait until the rotary part has stopped completely.</p> <p> You may injure your hands even when the part is rotating slowly.</p> <p>Do not touch</p>

Caution

<p> Wear gloves for disassembly, replacement and assembly.</p> <p>Make sure to wear gloves in order to prevent injuries by metal edges and electric shock when the power is turned on.</p>
--

2 Specifications

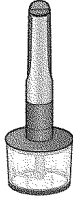
2.1. Spec. MX-S401/301

	Using blender attachment		Using chopper attachment		Using whisk attachment	
						
	MX-S401	MX-S301	MX-S401	MX-S301	MX-S401	MX-S301
Power supply	220 - 240 V ~ 50 - 60 Hz					
Power consumption	115 - 125 W			35 - 45 W		
Rated time (continuous operation)	1 minute			2 minutes		
Speed control	Changeable type					
Safety device	Motor overloading protection Motor overheating protection					
Length of power cord (approx.)	1.3 m					
Dimensions (approx.) Motor housing + Attachments (W × D × H)	6.5 × 7.4 × 42.3 cm		13.9 × 13.9 × 41.9 cm		6.4 × 7.3 × 46.7 cm	
Mass. (approx.) Motor housing + Attachments	0.8 - 0.9 kg		1.0 - 1.1 kg (Attach with chopper blade)		0.8 kg	

2.2. Spec. MX-S101

Power Supply	220 - 240 V ~ 50 - 60 Hz
Power Consumption	115 - 125 W
Rated Time (continuous operation)	1 minute
Safety Device	Motor overloading protection Motor overheating protection
Length of Power Cord (approx.)	1.3 m
Dimensions (approx.) Motor housing + Attachments (W × D × H)	6.5 × 7.4 × 42.3 cm
Mass. (approx.) Motor housing + Attachments	0.8-0.9 kg

3 Part Names and Instructions

(Exemplify by MX-S401/301)

Part Names and Instructions

Motor housing

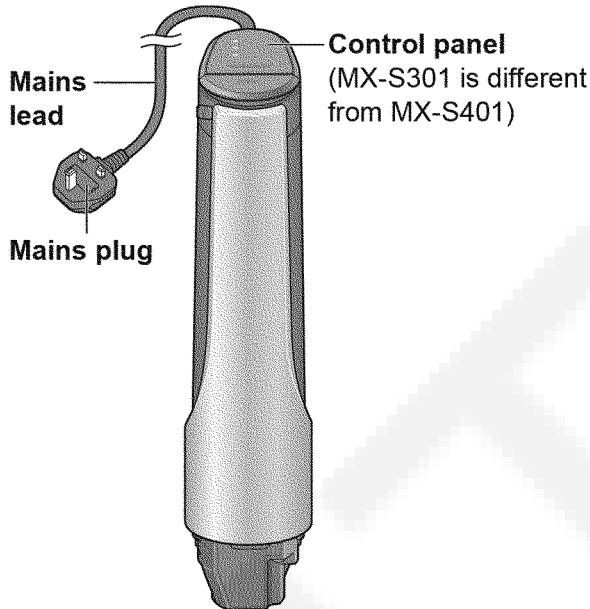

Chopper attachment

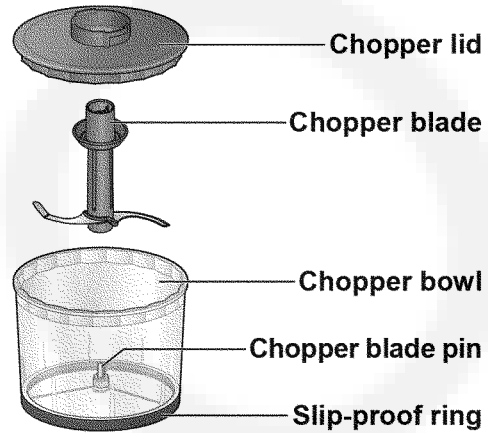

Whisk attachment & Adapter

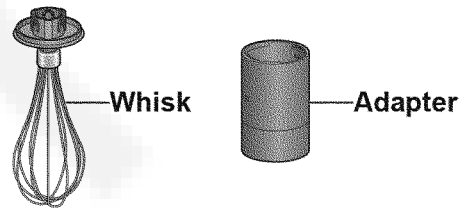

Blender attachment

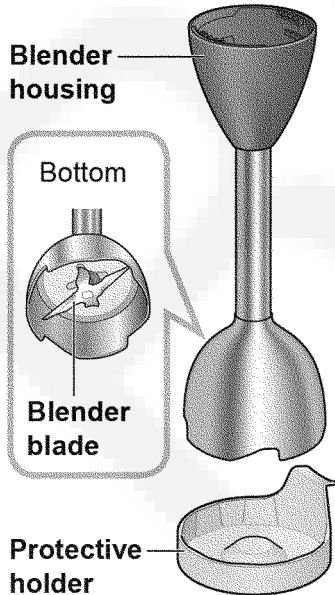

Use for placing or storing the blender temporarily.
For safety, it is attached to the blender at the time of purchase.

Accessories

Beaker
Maximum volume:
Approx. 700 mL, 16 oz/
2 cups

Minimum volume:
Approx. 100 mL, 4 oz/
0.5 cup

Lid/slip-proof mat
Can be used as a lid.
(Clean it before using.)

Spatula brush
Brush
Clean the blades.

Spatula
• For removing food.
• Removes the food stuck to the blades.

● Illustration color of product in this instructions are exemplified by MX-S401.

Part Names and Instructions (continue)

Control panel

(MX-S401)

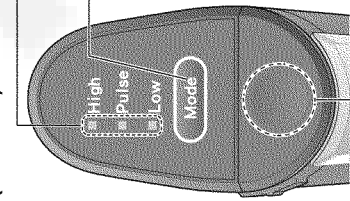

- Mode indicator**
Lights up to indicate the mode chosen with the mode selector.
- Mode selector**
Choose rotation speed [High/Pulse/Low (soft start)]. (P. 9)
- Initial settings: standby mode (All mode indicators are flashing.)
 - The machine will return to standby mode in following instances;
 - insert mains plug;
 - not in use for more than 30 seconds
 - motor overloading/overheating protection is activated.

Unlock button (⊞ section)

- Press the ⊞ section.
- Lock is released while the button is pressed. (When the trigger switch is pressed and rotation begins, the lock will not engage even if your finger is removed.)
- Cannot be pressed when child lock is locked.

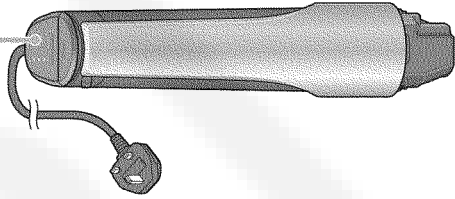

Mode

High

Continuous operation with high speed rotation.
(Use for making juice, smoothie by blender blade, minced meat by chopper blade, etc.)

Pulse (for MX-S401 only)

Repeated operation between medium speed and stop.
Uses the chopper blade and alternates between medium speed and stop for a grittier texture. (Use for chopping onion, fish, squid, prawn, etc.)

Low (soft start) (for MX-S401 only)

Starts slowly and then continues at low speed.
Starts slowly and then continues at low speed while whipping with the whisk attachment to prevent ingredients from flying out. (Use for whipping cream, making sauces, etc.)

Low (for MX-S301 only)

Continuous operation with low speed rotation.
(Use for chopping onion, fish by using chopper blade, etc.)

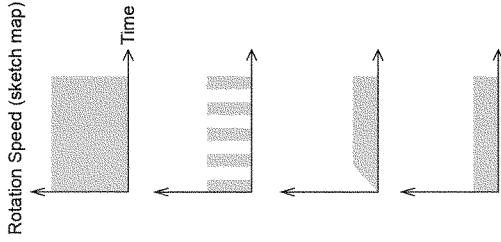

(MX-S301)

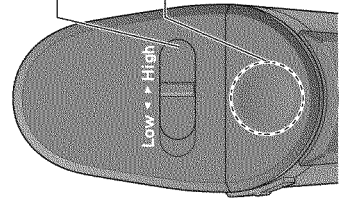

- Mode switch**
Choose rotation speed [Low/High].

Unlock button (⊞ section)

- Press the ⊞ section.
- Lock is released while the button is pressed. (When the trigger switch is pressed and rotation begins, the lock will not engage even if your finger is removed.)
- Cannot be pressed when child lock is locked.

Motor housing back

Back

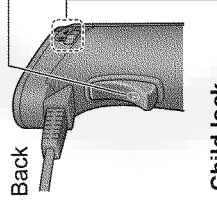

Trigger switch

- Press the trigger switch while holding down the unlock button to start the machine. (P. 14)
- The power will be "On" only while holding this switch.

Child lock

- Be sure to lock in the following instances:
- taking a break from blending;
 - carrying;
 - not in use;
 - attaching or removing attachments.
- The unlock button cannot be pressed while the child lock is locked.

Lock



Unlock



4 Preparations

Preparation

- Before using, wash parts except the motor housing and adapter. (P. 19)
- Make sure to handle according to the following instructions. (Cleaning & Care see P. 18-20)

Assembly and disassembly of attachments

Assembly of blender attachment

- 1 Align the ▼ on the motor housing with the ▲ on the blender housing.

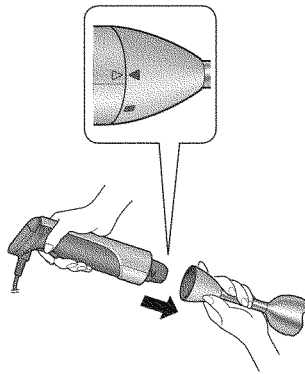

- 2 Twist the motor housing clockwise to align ▼ and ■ to lock until it cannot be rotated.

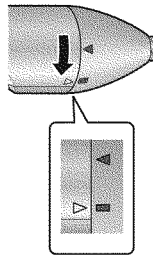

Reverse the steps to disassemble blender attachment.

Assembly of whisk attachment

- 1 Align the adapter and whisk attachment (below, 3 ○) and insert until a "click" sound is heard.

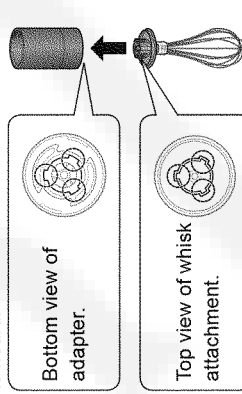

- 2 Align the ▼ on the motor housing with the ▲ on the adapter.

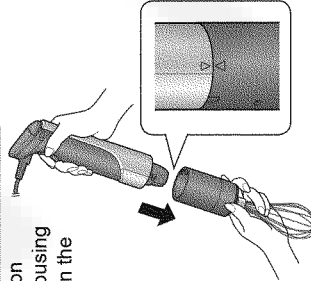

- 3 Twist the motor housing clockwise to align ▼ and ■ to lock until it cannot be rotated.

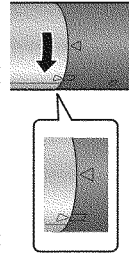

Reverse the steps to disassemble whisk attachment.

Assembly of chopper attachment

- 1 Insert the chopper blade into the chopper blade pin.
- 2 Close the chopper lid and face the ● on the lid to the front.
- 3 Align the ● on the adapter with the ● on the chopper lid.
- 4 Twist the adapter clockwise to align ● and ■ to lock until it cannot be rotated.

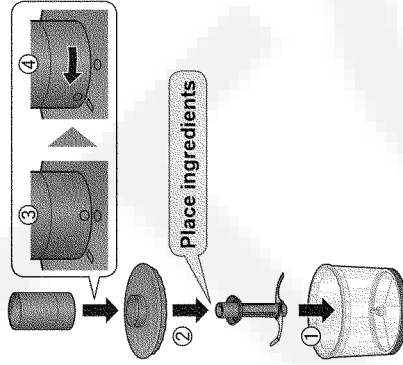

- The chopper blade is set with the chopper bowl at the time of purchase.

- 5 Align the ▼ on the motor housing with the ▲ on the adapter.

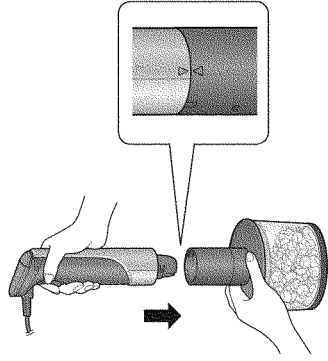

- 6 Twist the motor housing clockwise to align ▼ and ■ to lock until it cannot be rotated.

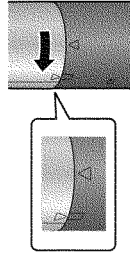

Reverse the steps to disassemble chopper attachment.

Handling Precautions

- Be sure to follow the rated time of each attachment. (P. 23)
- For continued use, unplug and rest machine for at least 10 minutes until motor housing returns to a normal temperature. (Cause of smoke, odour or malfunction due to motor overheating.)
- If the motor becomes hot from high load, repeated long use, insufficient rest time, or other factors, even if it is used within the rated time, the motor overheating protection function may be activated and the motor stops. (P. 20-21)

5 Prohibited Ingredients & Operating Instructions

Prohibited Ingredients & Conditions

Blending prohibited ingredients can cause damage to each attachment, beaker, chopper bowl and motor housing malfunction.



Blender attachment

- **Ingredients with rich fibers or muscles**
(Cause of malfunction by trapping fibers or muscles around the blender blade.)
 - Meats (includes chopped meat)
 - Fishes
- **Low moisture content ingredients**
(Cause of malfunction)
 - Boiled tubers*1
 - Boiled beans*1
(Kidney beans, butter beans, etc.)

- Coffee beans
- Ice cubes
- Dried soybeans
- Frozen food
- Turmeric

- **Strong sticky ingredients**
(Cause of malfunction)
 - Boiled tubers*1
(Potatoes, pumpkins, etc.)
 - Okra
 - Chilled cream cheese*2
 - Dough (bread, pasta, etc.)
- **Hard ingredients**
(Cause of blade damages)
 - Coffee beans
 - Ice cubes
 - Dried soybeans
 - Frozen food
 - Turmeric



Chopper attachment

- **Ingredients with rich fibers or muscles**
(Cause of malfunction by trapping fibers or muscles around the chopper blade.)
 - Fibrous meats
- **Hard ingredients**
(Cause of blade damages)
 - Coffee beans
 - Ice cubes
 - Dried soybeans
 - Frozen food
 - Turmeric



Whisk attachment

- **Whipping whole eggs or low fat cream (less than 30% milk fat) takes 2 minutes or longer.**
(Whole eggs cannot be whipped)

*1 Can be used by adding the same amount of water as ingredients.
*2 Can be used when the ingredients are in room temperature (approx. 25°C).

How to Use -Blender attachment-

Preparations

- **Cut soft ingredients into 2-3 cm cubes.**
- **Cut hard ingredients into 1 cm cubes.**
- **Wash leafy vegetables well and cut into 2-3 cm width pieces.**

Citrus

(Peel and separate.)



Apple

(Remove core and peel skin if desired.)



Carrots, etc.

(Peel)





(If pieces are too big, they cannot be mixed well.)

- Remove pit from peaches, plums and other stone fruits.
- Remove the stem end/ root, then wash well before use. (Spinach, etc.)
- Remove large stems from kale.

Notes

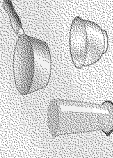
● Use a container or a pan that can be used with the blender. Hold the container firmly while in use.

Can use	Cannot use
<ul style="list-style-type: none"> • Beaker • Metal or plastic containers or pan. <p>Do not make contact with the rim or the bottom of container to avoid damaging it.</p> 	<ul style="list-style-type: none"> • Glass containers (including heat resistant and strengthened glass.) • Ceramic and earthenware containers and pots that are easy to break. • Chopper bowl 

● Do not use continuously for longer than 1 minute. (Cause of malfunction: P. 11)

● Follow the quantities that can be made in 1 batch.

- Do not add ingredients that exceed the height of the blender shaft.
- When adding liquid, follow the chart to the right.
- Depending on the type and quantity of ingredient, mixture may spill from the beaker or container. In such cases, reduce the quantity.

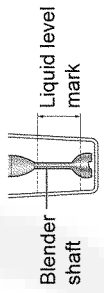

● Do not insert or remove the blender from the beaker, etc. while trigger switch is pressed. (It may cause injury and/or burn.)

● Attach blender attachment firmly. (P. 10)



How to Use -Blender attachment- (continue)

Preparation:

- ① Attach blender attachment to motor housing. (P. 10)
- ② Insert mains plug into mains socket.
- ③ Choose "High" mode. (P. 8-9)
- ④ Unlock child lock.

Unlock child lock



1 Insert blender into container.

2 Press trigger switch while holding down unlock button to start.

- Mix while pushing blender blade into the ingredients. (Do not push hard.)
- Hold beaker firmly so it does not lift up.
- Insert blender directly downwards when using beaker.
- When ingredients sticks to the container and is difficult to move, release trigger switch and reapply to ingredients. Then, restart again.
- Do not lift blender blade above the surface of liquid ingredients while in use. (Risk of splattering.)
- When handling in a pot or bowl, swirl the liquid at a slanted 5-10 mm without removing blender blade from the liquid. This will mix ingredients more smoothly.
- If device stops during use, see P. 21.

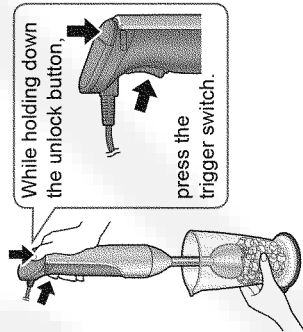

3 When finished, release trigger switch and lock child lock.

Confirm that rotation has stopped, then remove blender from container.

- The blender can be placed on the protective holder temporarily.

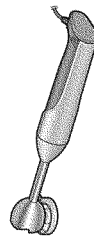

After Use

- Unplug the mains plug.
- Remove blender attachment and clean them. (P. 18-20)

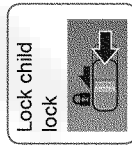

How to Use -Chopper attachment-

Preparations

- Cut into approx. 2-3 cm cubes.



- Remove peels, stems, seeds, and cores from ingredients.
- Cut hard ingredients (carrots, etc.) into approx. 1-2 cm cubes.
- Cut hard cheese such as parmesan, etc into 1 cm cubes. (Remove hard outer rind.)

- Remove parsley stalks.
- Wipe away excess water.

- Peel, devein, and remove legs on squid and prawn.
- Remove bones, gristle and tendons from meat.



- Remove nuts from shell.



- Thinly slice pork belly and cut into 2-3 cm length.

Notes

- Do not use continuously for more than 1 minute. (Cause of malfunction: P. 11)
- Scrape down ingredients that stick to the bowl during operation.



- Make sure that the chopper lid is not floating. (Cause of malfunction)
- Rotate lid and close again if it is not closed well.
- Be sure to attach slip-proof ring while in use.

The quantity and points of ingredient that can be used at a time.

- Choose appropriate mode according to the ingredients and finished condition.
- Be sure to follow the quantity that can be used at a time. (If quantity is too large, separate into batches.)

Ingredient	Min. - Max. (1 time)	Mode	Approximate time for handling		Main points of usage
			Power "On"	"Off" repeatedly	
Onion	40-200 g	Pulse	12-18 sec (MX-S401)		Cut to preferred size.
Carrot	40-200 g	Low	10-18 sec		
Parsley	5-30 g	High	10-30 sec		
Garlic	10-200 g	High	5-13 sec		
Nuts (walnut, etc.)	10-200 g	High	8-30 sec		
Slice of bread	10-80 g	High	15-30 sec		
Parmesan cheese	40-200 g	High	15-50 sec		
Meat (beef, pork, chicken, etc.)	80-200 g	High	5-20 sec		For rough finished condition, use "Pulse" mode for MX-S401, power "On" and "Off" repeatedly for MX-S301.
Fish	80-200 g	Low	5 sec-1 min		
Squid, prawn	80-200 g	Low	10 sec-1 min		

- When using only liquids, it should not exceed 50 mL.



How to Use -Chopper attachment- (continue)

Preparation:

- ① Attach chopper blade, place ingredients, and then close chopper lid. (P. 11)
- ② Insert mains plug into mains socket.
- ③ Choose appropriate mode. (P. 8-9)
- ④ Unlock child lock.

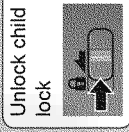

1 Press trigger switch while holding down the unlock button to start.

- Hold the chopper bowl firmly.
- Do not open the chopper lid while in use.

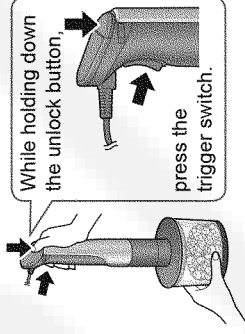

2 When finished, release trigger switch and lock child lock. Confirm that rotation has stopped, then remove blender from adapter.

- Unplug the mains plug.



3 Remove the adapter and chopper lid. After removed chopper blade, using a rubber spatula to take out the finished food.

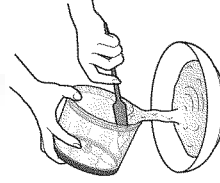

After Use

- Remove all parts and clean them. (P. 18-20)



How to Use -Whisk attachment-

Preparations

Keep cream and egg white in the refrigerator.

Notes

- Do not use continuously for longer than 2 minutes. (Cause of malfunction: P. 11)
- Use a large, deep bowl to minimize any splatter.
- Do not use more than 4 eggs when whipping egg whites.
- Attach whisk attachment firmly. (P. 10)
- Before using, wipe moisture from bowl and whisk. (Water residue prevents proper whipping.)

The quantity and points of ingredient that can be used at a time.

- Choose appropriate mode according to the ingredients and finished condition.

Ingredient	Max. (1 time)	Mode	Approximate time for handling	Main points of usage
Cream	Up to 200 mL (30% or more milk fat)	Low → High	Within 2 minutes	<ul style="list-style-type: none"> • Cool bottom of bowl with iced water. • Start "Low" mode and switch to "High" mode when it starts to thicken.
Egg whites	Up to 4 eggs	High	Within 2 minutes	-

- Cannot be used for mixing chilled butter or cream cheese, or kneading dough.

Preparation:

- ① Attach whisk attachment to motor housing. (P. 10)
- ② Insert mains plug into mains socket.
- ③ Choose appropriate mode. (P. 8-9)
- ④ Unlock child lock.

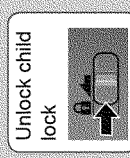

1 Place the whisk in a large and deep bowl.

Press trigger switch while holding down unlock button.

- When whisking, hold the motor housing perpendicular to the liquid surface and mix around the periphery of the bowl.
- Slightly tilt the bowl when using minimal ingredients.

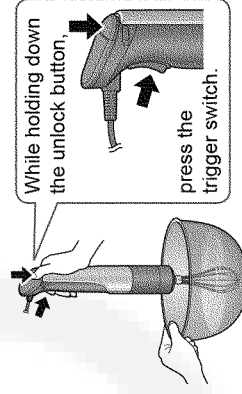



How to Use -Whisk attachment- (continue)

- 2** When finished, release trigger switch and lock child lock. Confirm that rotation has stopped, and then remove whisk from bowl.

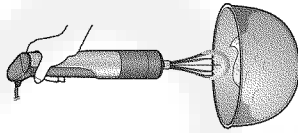
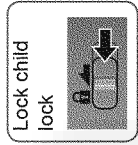

After Use

- Unplug the mains plug.
- Remove whisk attachment and clean it. (P. 18-20)

Cleaning & Care

Notes for Cleaning

- Be careful not to directly touch blades with your hands.
- Do not use benzine thinner, bleach, nylon face of sponge, metal brush, polishing powder, etc. (Otherwise, the parts surface will be damaged.)
- Do not use chlorine type detergents. (Cause of rust and breakdown.)
- Be sure to dry well after washing. (Risk of rust)
- Dry blender blades with blades pointing downwards.
- Do not clean the machine and attachments with a metal pointed object.

Notes for Storage

- Keep the machine out of reach of children. (Avoid personal injury.)
- Attach protective holder to the blender.

About Resin Parts Discolouration

Resin parts* may become discoloured through contact by the staining compounds in carrots and other vegetables. This discolouration cannot be fully removed with a sponge, but it poses no problem to use. Early cleaning after use can reduce discolouration.

* Blender housing, beaker, chopper bowl, chopper blade, protective holder.

Blender attachment

- 1 Pour approx. 200-300 mL of water into the beaker.
- 2 Choose "High" mode.
- 3 Run the blender for approx. 15 seconds. (P. 14)
 - Do not move up and down, otherwise, water may spill.
- 4 Replace water and repeat several times.
- 5 After removing leavings, wash with the spatula brush.

Blender housing

-
- Wash the bottom with a brush to avoid touching the blender blade directly.
 - Remove ingredients trapped between metal parts with the spatula brush.
 - If cannot clearly clean, try to use a non-metallic pointed object (made of wood is recommended). (Do not touch rubber portion.)

Motor housing & Adapter

Wipe with a well-wrung cloth.

Water entering the inside of the machine can cause malfunction.

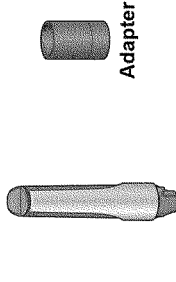

Other Parts

Wash with diluted dish detergent (neutral).

- Use a brush to clean chopper blade and chopper blade pin.

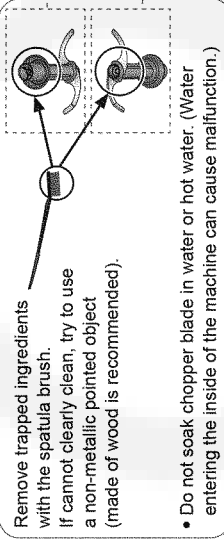

Remove trapped ingredients with the spatula brush. If cannot clearly clean, try to use a non-metallic pointed object (made of wood is recommended).

- Do not soak chopper blade in water or hot water. (Water entering the inside of the machine can cause malfunction.)

- Use a soft sponge to clean lid/slip-proof mat and slip-proof ring.

Lid/slip-proof mat

Wash it after removing from beaker.



Slip-proof ring



Wash it after removing from chopper bowl.



Cleaning & Care (continue)

Use of Dishwasher and Dish Dryer

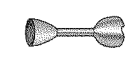
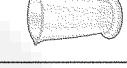
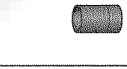
Safe ✓ / Unsafe ✗

Motor housing	Blender attachment	Beaker	Adapter	Chopper attachment	Whisk attachment
					
✗	✓	✓	✗	✓	✓

- Use a detergent intended for use with a dishwasher machine. (Use after thoroughly referring to the user manual accompanying your dishwasher.)
- The beaker and chopper bowl may become fragile. Distance these items from the heating element, and set temperature to low if using a model with heat control.

Troubleshooting

Please check following points before calling or arranging for repair.

Problem	Cause and Action
Button cannot be pressed.	<ul style="list-style-type: none"> • Child lock does not unlock. (P. 9) • Did not hold down the unlock button beforehand. (P. 8)
Does not operate even when button is pressed.	<ul style="list-style-type: none"> • The mode is not chosen. (Only apply for MX-S401) <ul style="list-style-type: none"> ➔ Choose a kind of speed mode. ➔ Securely insert it. • Motor overheats, activating the motor overheating protection function. (All mode indicators of MX-S401 are flashing.) <ul style="list-style-type: none"> ➔ Unplug and rest the machine for approx. 30 minutes or more (until motor housing returns to a normal temperature) to release overheating protection before using again. If the machine still does not operate, consult the store of purchase or Panasonic service centre.
Large vibrations	<ul style="list-style-type: none"> • Did not follow the indicated ingredient portion for 1 batch. (P. 13, P. 15, P. 17) • Did not prepare the ingredients to the indicated sizes. (P. 13, P. 15) • Ingredients are hard. <ul style="list-style-type: none"> ➔ Remove the hard ingredients.
The blade gets stuck.	<ul style="list-style-type: none"> • Unplug and remove ingredients trapped between metal parts with the spatula brush. If cannot clearly clean, try to use a non-metallic pointed object (made of wood is recommended). (Do not touch rubber portion.)

Problem

Motor housing becomes hot.	<ul style="list-style-type: none"> • Use beyond rated time. <ul style="list-style-type: none"> ➔ Use within rated time (P. 23). For continued use, unplug and rest machine for at least 10 minutes until motor housing returns to a normal temperature. (Motor overheating causes malfunction.) • Ingredients are hard. <ul style="list-style-type: none"> ➔ Remove the hard ingredients. ➔ Chopper lid is not set properly. <ul style="list-style-type: none"> ➔ Reset the chopper lid properly. (P. 15)
There is abnormal noise.	<ul style="list-style-type: none"> • Motor overloading protection is activated due to overload. (The mode indicator of MX-S401 goes off.) <ul style="list-style-type: none"> ➔ If blender is pressed strongly against ingredients, release trigger switch and unlock button, unplug the machine, then reinsert to operate again. (P. 14) <ul style="list-style-type: none"> • Do not press blender forcefully into ingredients. ➔ For circumstances other than the above, perform the following steps while the blender is stopped. <ol style="list-style-type: none"> 1 Release trigger switch and unlock button, then remove motor housing from the container. 2 Unplug the mains plug. 3 Remove half of the ingredients or add water. <ul style="list-style-type: none"> • If prohibited ingredients were added, remove them. 4 Repeat preparation and operation. (P. 14, P. 16, P. 17-18) <ul style="list-style-type: none"> • Do not press blender forcefully into ingredients.
Operation stops abruptly.	<ul style="list-style-type: none"> • Motor overheating protection function activated from motor overheating during or after use. (All mode indicators of MX-S401 are flashing.) <ul style="list-style-type: none"> ➔ Unplug and rest the machine for approx. 30 minutes or more (until motor housing returns to a normal temperature) to release overheating protection before using again. (If machine still does not operate, consult the store of purchase or Panasonic service centre.)
Starting and stopping alternately.	<ul style="list-style-type: none"> • Chosen "Pulse" mode. (Only apply for MX-S401) <ul style="list-style-type: none"> ➔ "Pulse" mode alternates between medium speed and stop. (P. 9)
Ingredients do not mix well.	<ul style="list-style-type: none"> • Did not follow the indicated ingredient portion for 1 batch. (P. 13, P. 15, P. 17) • Did not prepare the ingredients to the indicated sizes. (P. 13, P. 15) • Ingredients are hard. <ul style="list-style-type: none"> ➔ Remove the hard ingredients. ➔ Operating time is short. <ul style="list-style-type: none"> ➔ Lengthen operating time, but not exceed the rated time of continuous operation. • The chosen speed mode is not appropriate. <ul style="list-style-type: none"> ➔ Choose appropriate speed mode.
Poor finished product.	<ul style="list-style-type: none"> • The blade is damaged. <ul style="list-style-type: none"> ➔ Stop using and contact the store of purchase or Panasonic service centre.

Cause and Action

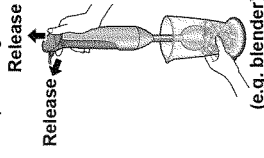

(e.g. blender)

6 Schematic Diagram

- We request you to do the following.
- Please, Wiring Connection Diagram choose and read the Diagrams II / Parts List of the upper left.

6.1. Model MX-S401

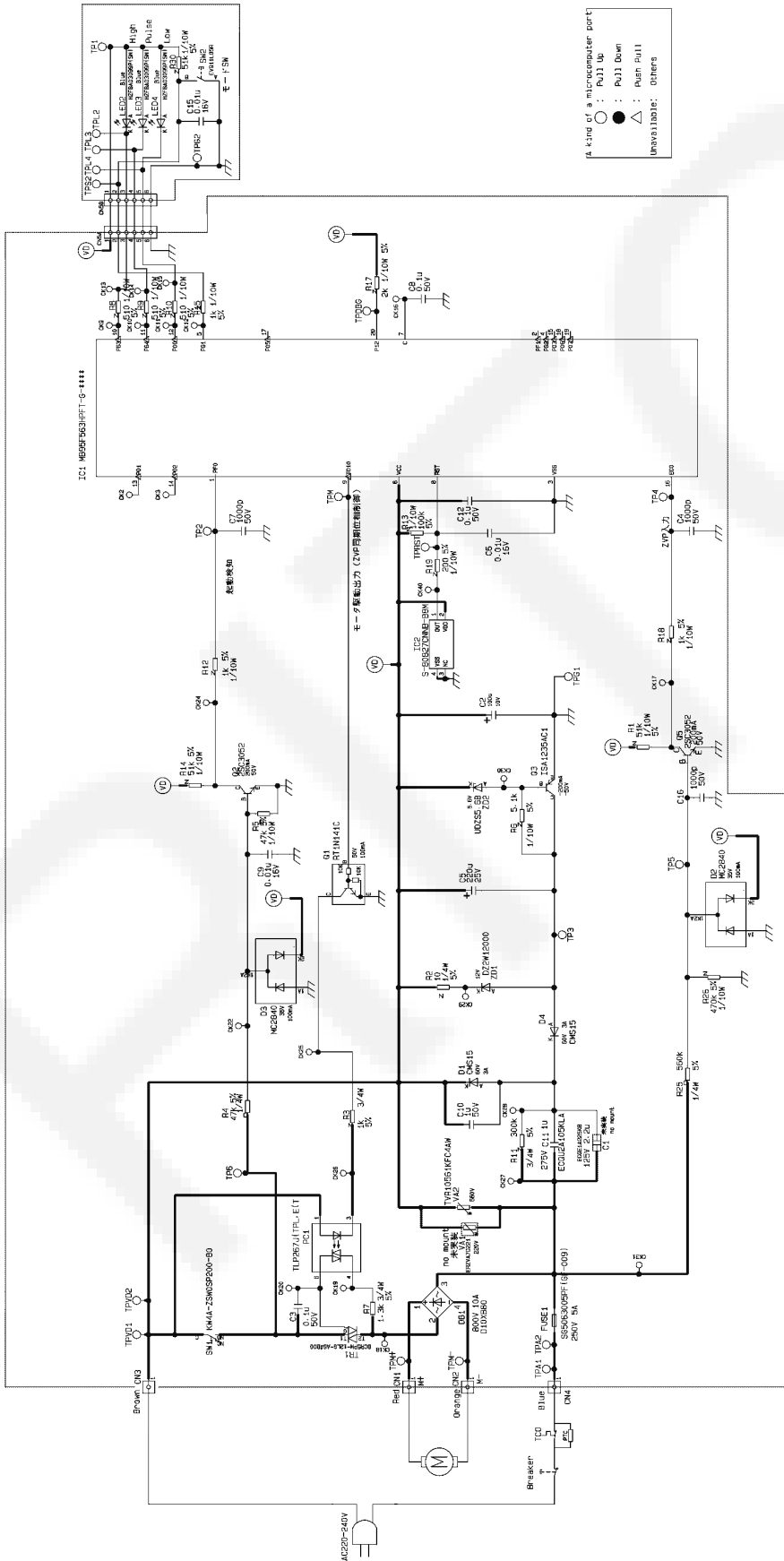

6.2. Model MX-S301

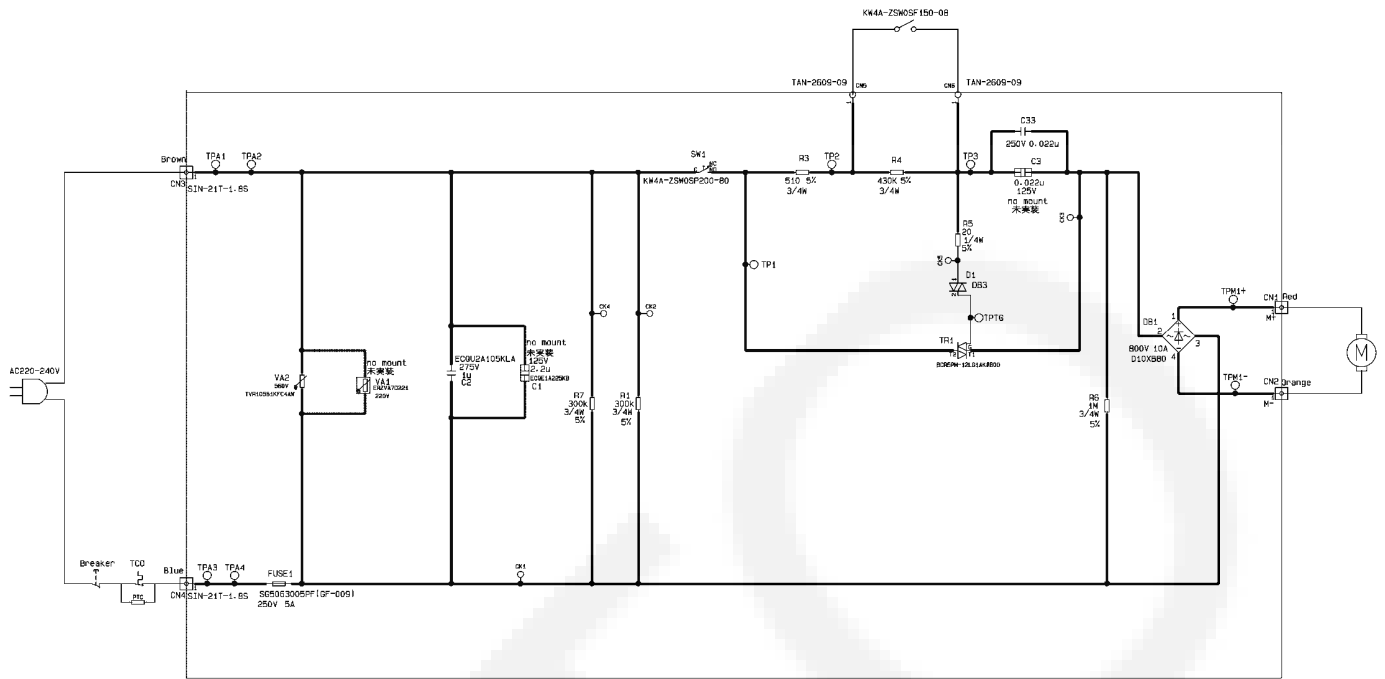

6.3. Model MX-S101

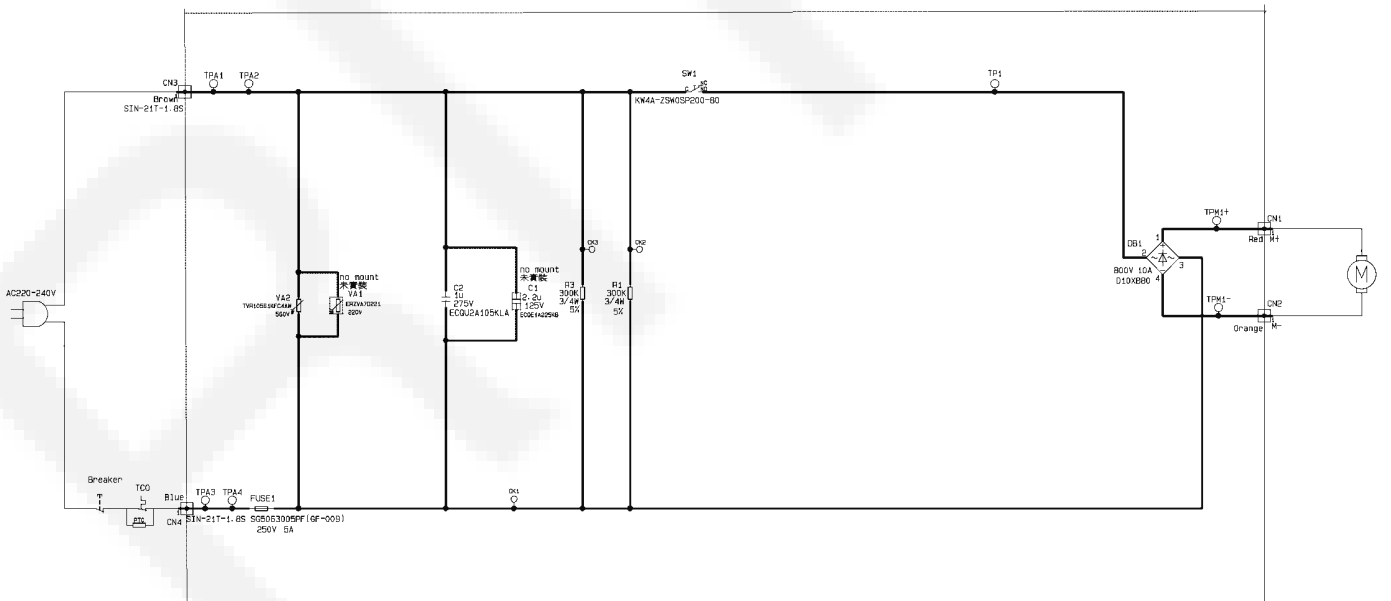

7 Exploded View and Replacement Parts List

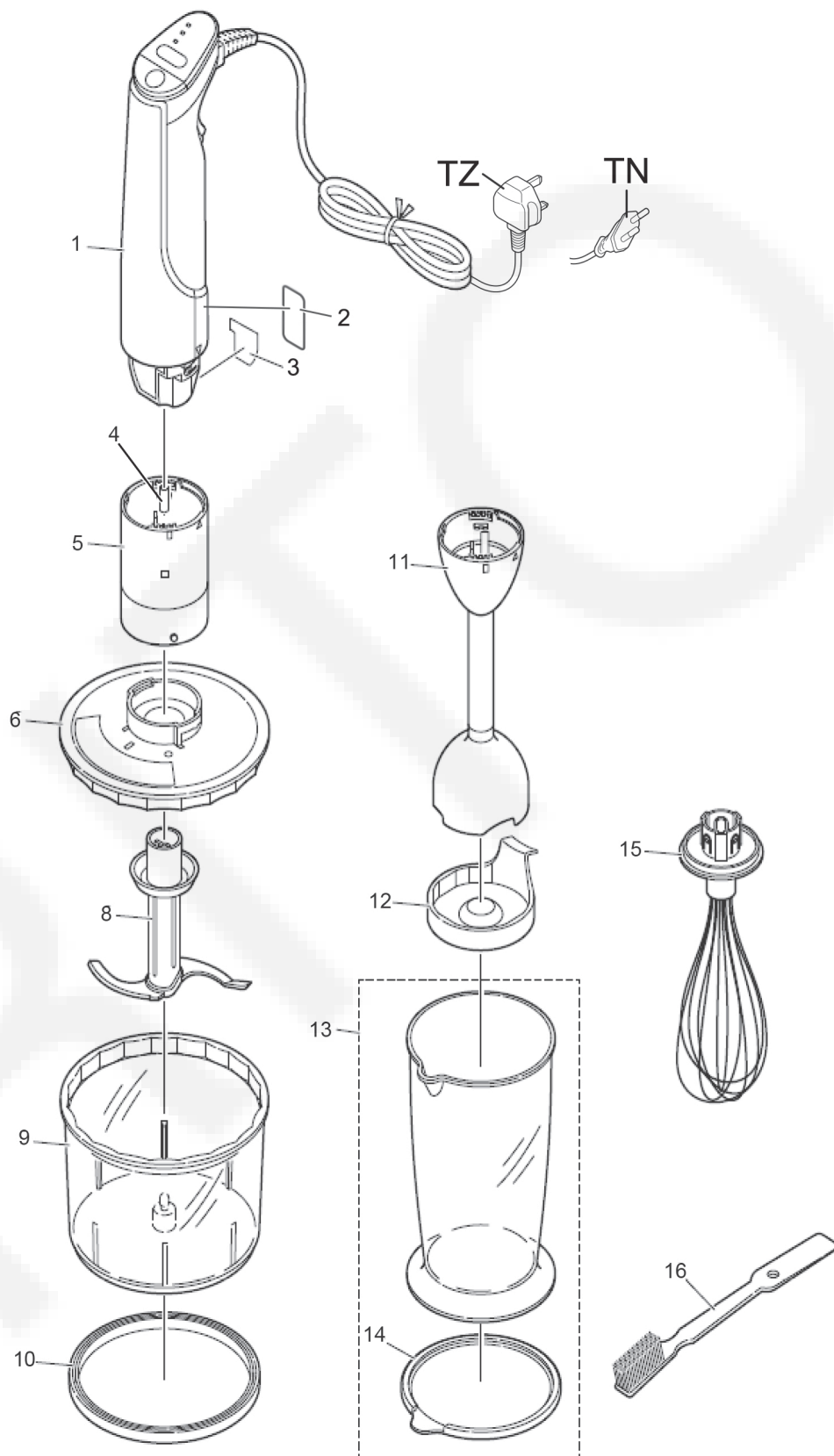

7.1. Replacement Parts List

Notes: Important safety notice

- Components identified by \triangle mark have special characteristics important for safety.
- " When replacing any of these components use only manufacturer's specified parts."
- Please order 'Individual box' ten by a unit.

Safety	Ref. No.	Part No.		Part Name & Description	S401	S301	S101
		TN	TZ				
\triangle	1	AMA02Q142-S0U	AMA02J142-S0U	MOTOR HOUSING OF HAND BLENDER	1		
\triangle	1	AMA02Q143-K1U	AMA02J143-K1U	MOTOR HOUSING OF HAND BLENDER		1	
\triangle	1	AMA02Q144-W1U	AMA02J144-W1U	MOTOR HOUSING OF HAND BLENDER			1
	2	-	AMY22J1421	GCC LABEL	1	1	1
\triangle	3	AMY21Q142	AMY21J142	NAMEPLATE A	1		
\triangle	3	AMY21Q143	AMY21J143	NAMEPLATE A		1	
\triangle	3	AMY21Q144	AMY21J144	NAMEPLATE A			1
	4	AMB40-142		JOINT TUBE	1	1	
	5	AMA07-142-K1		ADAPTER	1	1	
	6	AMD05E142-K1		CHOPPER LID	1	1	
	8	AMB95-1421K1U		CHOPPER BLADE	1	1	
	9	AMD00-1421		CHOPPER BOWL	1	1	
	10	AMD03-142-K0		CH RUBBER HOOT	1	1	
	11	AMA18E1421S0U		BLENDER HOUSING	1		
	11	AMA18E1431K1U		BLENDER HOUSING		1	
	11	AMA18E1431W1U		BLENDER HOUSING			1
	12	AMU01-142		CUTTER HOLDER	1	1	1
	13	AMA37E142-00U		BEAKER	1	1	1
	14	AMD17-1421K0		BEAKER RUBBER HOOT	1	1	1
	15	AMA34-142100U		WHISK	1	1	
	16	AMU00-142-K0		SPATULA BRUSH	1	1	1
Packing Specification							
		AMZ01Q142-S0		INNER CASE	1		
		AMZ01Q143-K1		INNER CASE		1	
		AMZ01Q144-W1		INNER CASE			1
		AMZ02G142		CUSHION (TOP)	1	1	
		AMZ03G142		CUSHION (BOTTOM)	1	1	
		AMZ02G144		CUSHION (TOP)			1
		AMZ03G144		CUSHION (BOTTOM)			1
\triangle		AMZ50Q142		OPERATING INSTRUCTIONS	1	1	
\triangle		AMZ50Q144		OPERATING INSTRUCTIONS			1
		AMZ23-142		CUSHION FOR CHOPPER UNIT	1	1	
		MZ68-142		LID PROTECTION SHEET	2	2	
		MZ22B142		CUSHION FOR BEAKER	1	1	1
		VZ07-253		PE FILM	2	2	1
		XZB10X40B03		PE BAG	1	1	1