

Service Manual

Washing Machine

Panasonic®

NA-F5510P/F50E1P

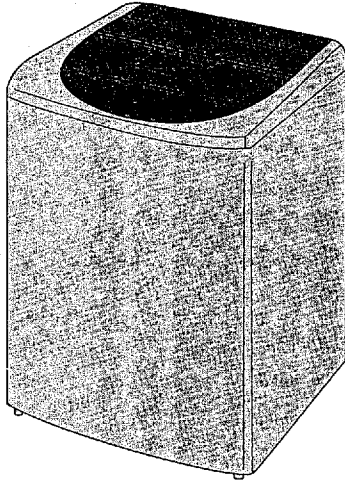

Specifications

Power source	AC220V 50Hz		Spin r.p.m (Clothes load)	850r/min	
Dimension	(Width) (Depth) (Height) 520mm 550mm 938mm		Machine weight	30 kg	
Water level selector (standardized water amount)		Water Load	Clothes Load	Power consumption (Motor/wash) (Motor/Spin)	
	H	54L	49L		Input 380W,Output 130W Input 305W,Output 130W
	M	48L	44L	Safety swich	Lid and unbalance switch
	L	41L	39L	Buzzer	Cycle-end buzzer, Give an alarm
Standardized water consumption	H160L,M145L,L131L		Thermal protector	Motor	
Operateing Water pressure	0.03~1Mpa (4.3p.s.i~142p.s.i)		Softner dispenser	○	
Pulsator r/min (Clothes load)	140r/min		Bleach inlet	○	
			Lint filter	○	
			Auto power off	○	
			Accesories	Pressure hose (Inlet hose) Feed valve joint A Service hose Cleaning plate	

Panasonic®

© 1998 Matsushita Electric Industrial Co., LTD. All rights reserved. Unauthorized copying and distribution is a violation of law.

⚠ WARNING

This service information is designed for experienced repair technicians only and is not designed for use by the general public. It does not contain warnings or cautions to advise non-technical individuals of potential dangers in attempting to service a product. Products powered by electricity should be serviced or repaired only by experienced professional technicians. Any attempt to service or repair the product or products dealt with in this service information by anyone else could result in serious injury or death.

IMPORTANT SAFETY NOTICE

There are special components used in this equipment which are important for safety. These parts are marked by ⚠ in the Schematic Diagrams, Circuit Board Diagrams, Exploded Views and Replacement Parts List. It is essential that these critical parts should be replaced with manufacturer's specified parts to prevent shock, fire or other hazards. Do not modify the original design without permission of manufacturer.

CONTENTS

	Page		Page
1 INSTALLATION INSTRUCTION	2	5 CHECK INPUT AND OUTPUT VOLTAGE OF THE P.C BOARD	15
2 FEATURE AND TECHNICAL EXPLANATION	7	6 TEST RUNNING WITHOUT WATER	16
3 FEATURE AND TECHNICAL EXPLANATION	8	7 SCHEMATIC DIAGRAM	17
4 DISASSEMBLY INSTRUCTIONS AND ADJUSTMENTS	12	8 SMALL STANDARDIZED METAL PARTS	24

1 INSTALLATION INSTRUCTION

1.1. Check Installation Location

■ Place the washing machine on a horizontal floor.
(Place the washing machine 5 cm or more away from the wall to prevent noise.)

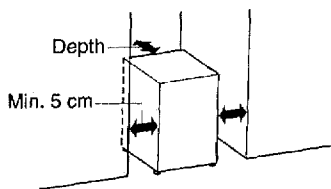

Do not install the washing machine in any extremely damp place such as a bathroom, or in a place exposed to the weather.
There is a danger of electric shock, fire, machine trouble and deformation of machine.

Improper examples

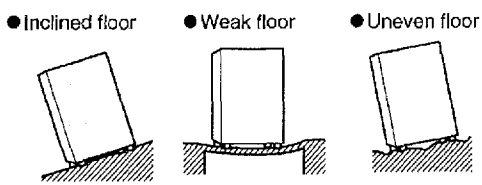

- Do not install the washing machine in any of the following places.
 - A place where freezing is likely to occur in winter.
 - A place exposed to direct sunlight
 (These could cause machine trouble, deformation and other problems.)

1.2. Connect tap adapter to water faucet

■ Suitable water faucet

Horizontal water faucet

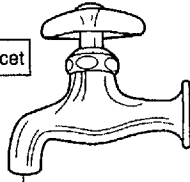

Water faucet diameter: max. 24 mm

- When the diameter is 24 mm or more, use a large-sized water tap adaptor (AXW12H-4130) (sold separately).

- The optional branch faucet (CB-A3) specifically designed for the washing machine will eliminate the need for connection and removal of the supply water hose.

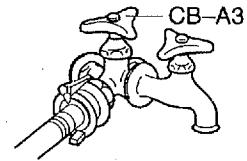

- The connector cannot be used with an extension or an all-purpose home faucet. In these cases, use the CB-J3 faucet (sold separately). Leaks will result otherwise.

Extension

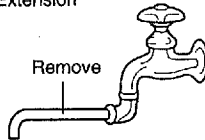

All-purpose home faucet

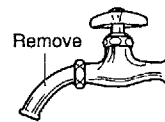

CB-J3

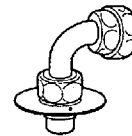

■ How to connect

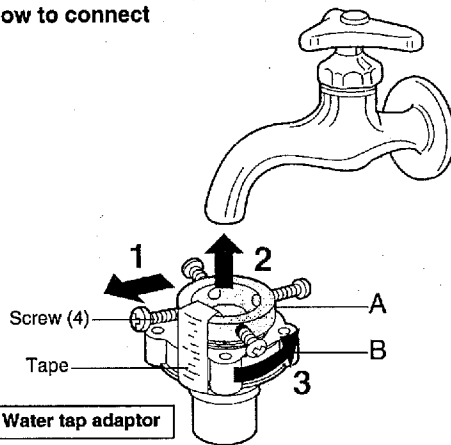

- 1 Loosen the four screws on the water tap adaptor just enough to slip the adaptor over the mouth of the faucet
- 2 Slip the connector over the faucet, keeping it in a straight line with the faucet. Tighten the screws by applying even pressure all around. (4 screws)
※When the space behind the washing machine is narrow due to a wall or other obstacles, adjust the back screw beforehand.
- 3 Remove the tape, and secure B to A by turning B to the right.

- When the diameter of the water faucet is 18 mm to 24 mm

Loosen the four screws and remove the ring beforehand.

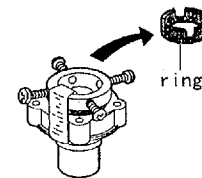

Firmly tighten part B of the water tap adaptor.

Otherwise, water leakage will result.

Attention

- If a water tap adaptor is already connected, replace with the attached new one.
- When the hose must be reinstalled (after you move, for example), turn B to the left until about 4 mm of the thread becomes visible, then carry out the procedures described above.

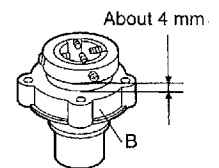

1.3. Connect external drain water hose

■ How to connect the external drain water hose

1 Insert the external drain water hose securely in the connecting section of the machine and move the hose band to the inner end.

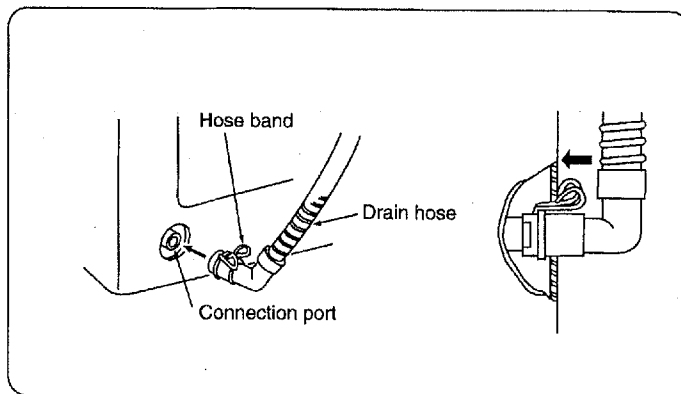
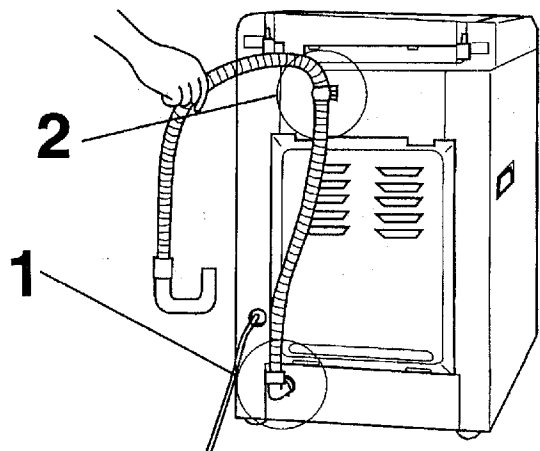

2 Fix the external drain water hose by the hose supporter and securely fasten the screw.

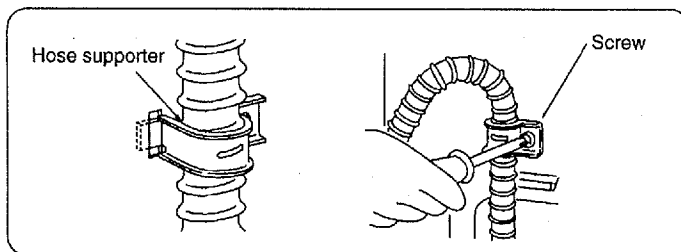

● Hose height should be 1m or less.

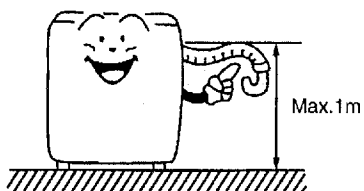

● Do not extend the hose.

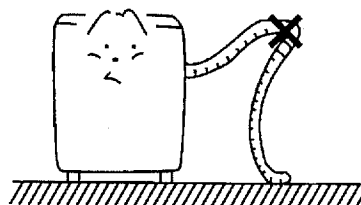

● Do not put the hose end in the water.

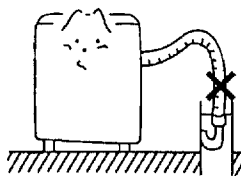

Bad example

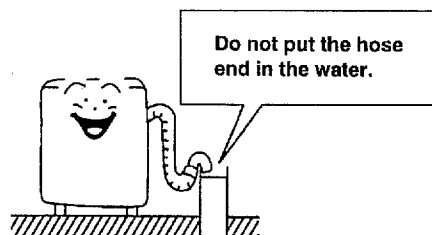

Good example

1.4. Connect supply water hose

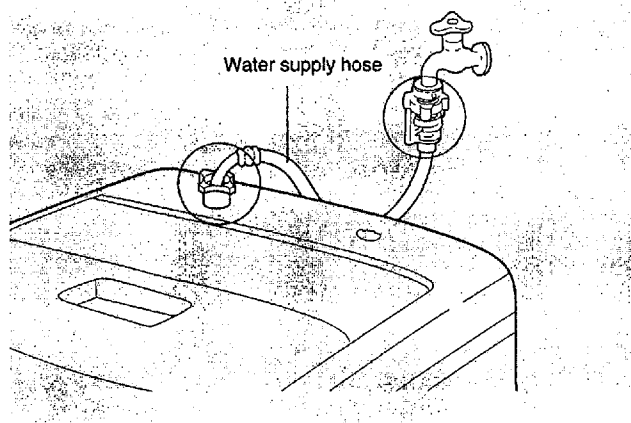

■ To extend water supply hose

- Purchase an extension water-supply hose at distributors.

Length	0.5m	1m	2m	3m	5m
Product No.	AXW1251 -250	AXW1251 -201	AXW1251 -202	AXW1251 -203	AXW1251 -205

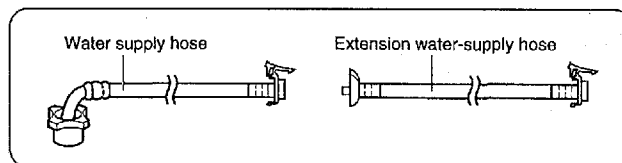

■ How to connect to water tap adaptor

- 1 With the water supply hose cover and lever pushed down, slide the hose up onto the connector until you hear it click into place. (Pull down on the hose to make sure it will not come off.)

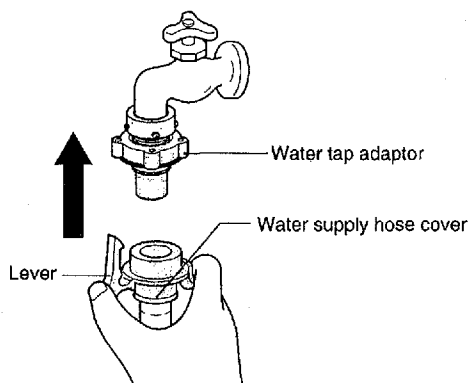

■ How to connect to the product

- 1 Push the water supply hose nut straight onto the water supply valve screw.
- 2 Hold the elbow while lifting it up, screw the nut onto the water supply valve screw, and firmly tighten the nut. (Check whether or not the elbow is unsteady or loose.)

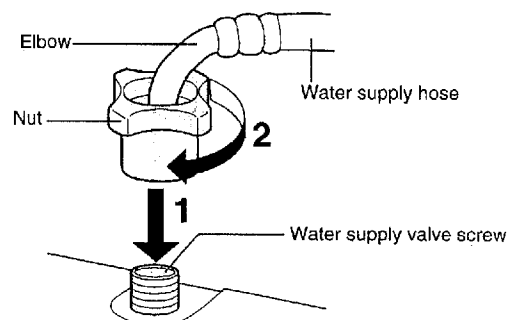

■ How to remove hose

- 1 Close the faucet.
- 2 Turn on the power and press the Start button. Then drain water from the hose.
- 3 After a few seconds, turn off the power.
- 4 With the lock lever pressed, push down the cover to remove it.

Firmly tighten the nut.

Otherwise, water leakage will result.

Do not let the hose straight toward the back.

The hose may be bent and result in water leakage.

1.5. Establish a ground (In case of two-wire power cords)

- When there is a grounding receptacle on power supply outlet

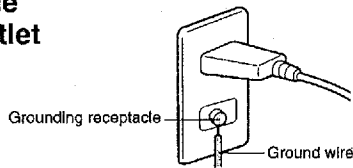

Establish a proper ground.

Otherwise, electric shock will result when equipment damage or leakage current occurs.

- Contact distributors for grounding work.

- When carbon ground rod (sold separately) is used

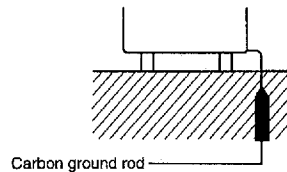

- Do not connect to gas pipe, water pipe, or ground wire of telephone or lightning rod.
- Reestablish a ground when you change installation location or move.
- For further information, contact the distributor or service technician.

2 FEATURE AND TECHNICAL EXPLANATION

2.1. Fuzzy sensor control

Control system based on fuzzy logic detects the amount of laundry and indicates the proper water level and recommended amount of detergent.

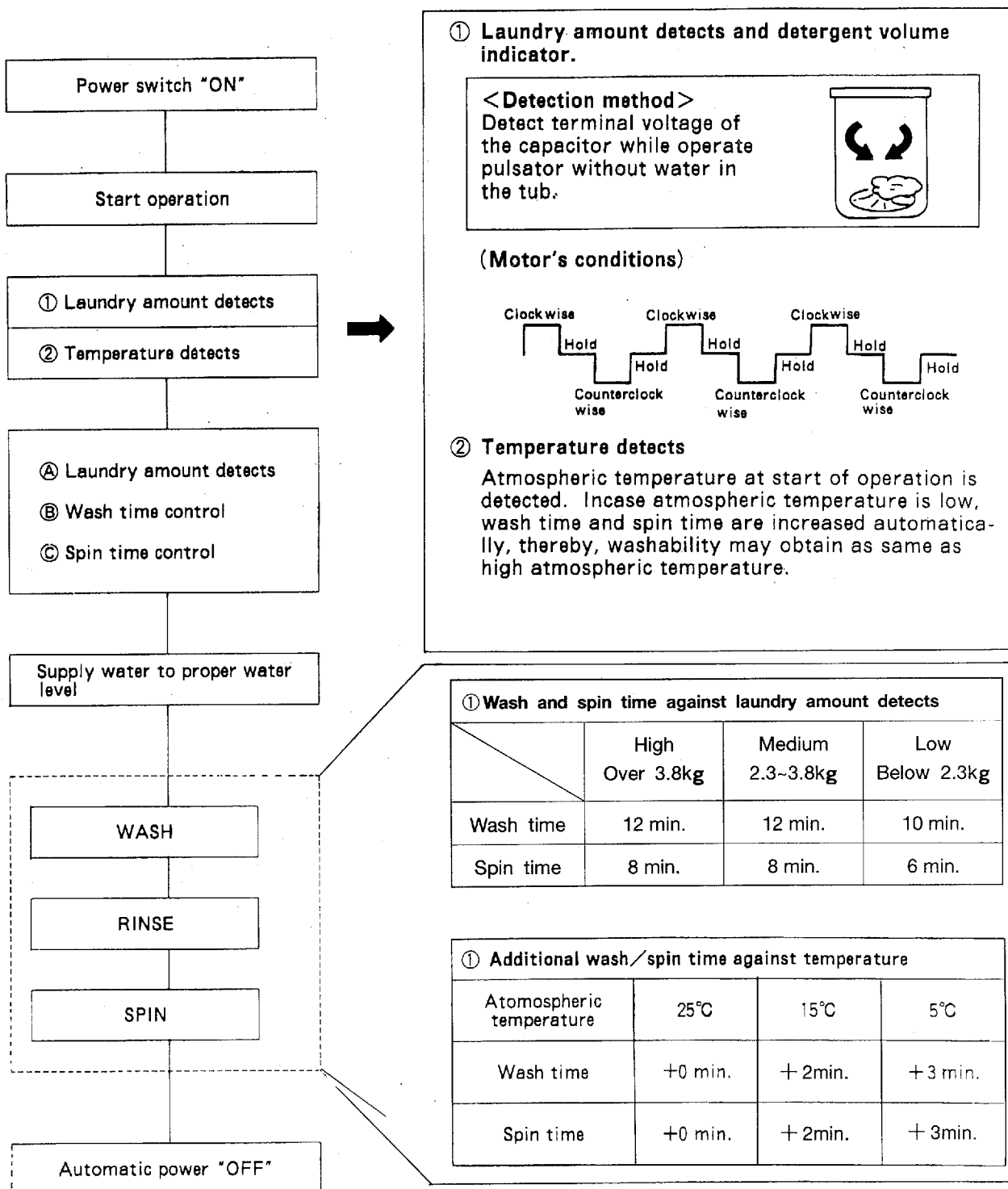

3 FEATURE AND TECHNICAL EXPLANATION

3.1. Home Dry Care Course(Preparation)

3.1.1. Confirm whether or not your clothes can be washed.

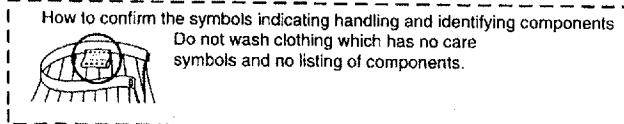

3.1.1.1. Washable items (item can be washed in water, but cannot be scrubbed or handled roughly during washing)

- High-quality, delicate items with care symbol indications such as (P) or (P) for how to handle them

(Examples) Cashmere sweater Linen blouse Lamé-mixed fabric summer sweater Slacks, etc.

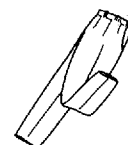

(However, some items with the (P) symbol cannot be washed.) → (See "Clothes that cannot be washed" shown below)

3.1.1.2. Clothes that cannot be washed (because the problems below occur when immersed in water)

(Examples) (1) Coat



(1) Jacket



(3) Cheongsam



(3) Leather product



1. Garment that has much interfacing and padding, etc., and that can easily become misshapen when immersed in water (Necktie, blazer coat, jacket, coat, one-piece dress, ensemble (suit or other 2-piece outfit), etc.)
2. Clothing without care symbols indicating handling
3. Material which could undergo significant shrinkage, discoloration or surface change when immersed in water (Rayon, silk, fabric woven of rayon or silk mixed yarn, leather products, fur, etc.) (Attention) Do not wash any item made of unknown material.
4. Fabric which could undergo significant shrinkage or surface change when immersed in water (Wool and cotton fabric woven using hard twist yarn, georgette, crepe, silk crepe, etc.)
5. Item with surface texture that disappears when immersed in water (Wrinkle-processed material and emboss-processed material) (Attention) Test by dripping a few drops of water on a part of clothing which is not noticeable. If the unevenness of the surface of the material disappears, do not wash this item.
6. Fabric with color that runs easily when immersed in water (See page for details "How to check for non-colorfastness".)
7. Fabric with a raised surface that becomes flattened when immersed in water, and fabric which has a raised surface (Velvet and velveteen)

3.1.1.3. What is the "Home Dry Care" course?

- This machine gently washes high-quality, delicate garments that previously had to be hand-washed at home.
- Most suitable for cleaning delicate fabrics, etc. after they have become sweaty
- Be sure to read the instructions on pages before you use this course for washing delicate clothes.
- Do not use any detergent other than liquid neutral detergent (for washing wool yarns and delicate garments, and containing no fluorescent agents) to prevent undissolved detergent and bad effects on textiles.

3.1.2. How to check for non-colorfastness

Select an inconspicuous part of the garment. Place a white towel under the cloth, pound the garment about 10 times with another white towel soaked with undiluted liquid neutral detergent (for clothing). If the color of the garment is transferred to the towel, do not wash the garment.

- Be particularly careful to check dark red or dark blue garments for non-colorfastness.
- It is difficult to determine non-colorfastness for light colors such as yellow; for these colors, check for transfer of color after you have dried the towels.

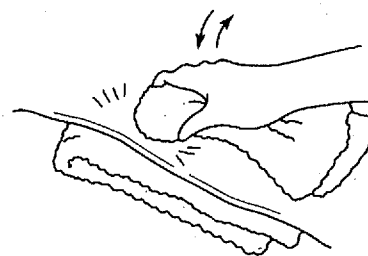

3.1.3. Method of pre-treating heavily soiled spots

Place a towel behind the part where there is heavy soiling or stubborn dirt (for example on collar and sleeves). Using plain water, wet the area surrounding the soiled spot, then apply liquid neutral detergent (for clothing) to the spot, and lightly tap the dirty spot using a soft brush. (Do not scrub.)

(For this pre-treatment, use only detergent containing no fluorescent agents)

- Some stains due to chemical changes, for example, those caused by permanentwave solution, ironrust, mildew, ink, India ink, or lipstick, and fabric yellowing or discoloration caused by sunlight, can't be removed.
- The longer you leave a stain as-is, the harder it is to remove.
Treat stains as soon as possible.

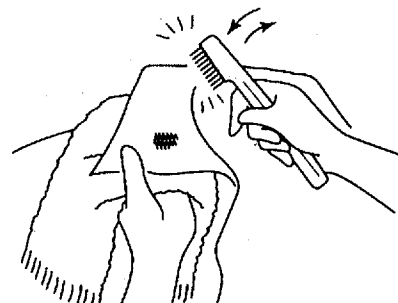

3.1.4. Preparation of clothing before washing

- Do up buttons and other fasteners.
- Cover dark-colored buttons tightly, using (plastic) cooking wrap to prevent colorfastness.
- Using a needle and thread, baste each pleat of pleat-processed wool material, etc., to keep the pleats from opening.

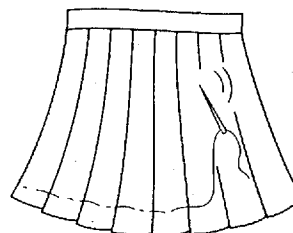

3.1.5. Key points for washing

- Use tap water (30 °C or lower). (Do not use hot water or leftover bath water.)
- Sometimes the wash water doesn't soak into the clothing easily, depending on the variety of detergent and type of clothing; if this occurs, press down lightly on the clothing to soak it thoroughly.

3.2. Home Dry Care course(Finishing)

3.2.1. Key points for drying(Do not use a dryer.)

- Dry white and light-colored items, wool, and nylon, in the shade.
- Smooth out creases and wrinkles from knitted products and from clothing made of "new" synthetic fibers, and adjust the shape of each article by gently patting it with your palms, then dry the clothing.
(In this way, you can save the time and work of ironing, and the "touch" of each garment will be nicer.)

(Examples of how to dry)
Hang dry (knit product, etc.)



Drying using a hanger (shirt, blouse, etc.)
(Do not dry a knitted product on a hanger.)



Flat drying (coarsely-stitched knitted product)
(Use a purchased net for flat-drying or a bathtub cover other than that made of wood.)

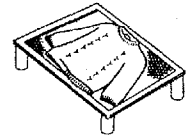





3.2.2. Key points for ironing

Different ironing techniques depending on material

Steam ironing	suitable for wool and mixed-spun materials.
Dry ironing	suitable for synthetic materials.
Spray-and-iron	suitable for cotton and linen materials. * Use dry ironing for finishing and do not allow any moisture to remain in the material.

Materials and appropriate ironing temperatures

	About 110°C for acrylic and nylon fabrics
	About 150°C for wool, cupra, polyester, acetate
	About 200°C for cotton and linen
	* Never iron an item labeled with this symbol.

How to use a pressing cloth

- Use a pressing cloth when ironing skirts and slacks which can easily become shiny, and when ironing embroidered or beaded garments.

3.2.2.1. Ironing sweaters and knits

Overall finishing



Hold the bottom surface of the iron so it barely touches the surface of the sweater or knitted item, and apply steam all over the item.

Partial finishing, for cuffs, etc.

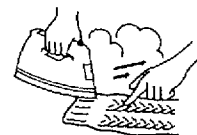

While pulling the cuff, etc., in the direction of the length of the garment, adjust the shape of the cuff, etc.

Use sufficient steam on the elongated rib-stitch part.

* Never press-iron a sweater. (Iron sweaters gently to preserve their soft feel)

3.2.2.2. Ironing skirts

Ironing a gathered skirt

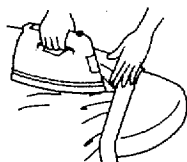

Insert the tip of iron into each gather of the skirt and press while quickly pulling out the iron.
Use the hand not holding the iron to hold the waistband of the skirt.

Ironing a pleated skirt



Arrange about 3 pleats neatly and press the hem of the skirt to set the pleats in place, then iron the pleats while moving the iron toward the waistband. Use the hand not holding the iron to pull gently on the waistband.

3.2.2.3. Ironing slacks

Align the outer and inner seams of one leg of the slacks

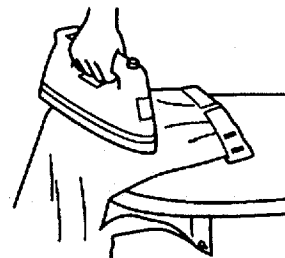
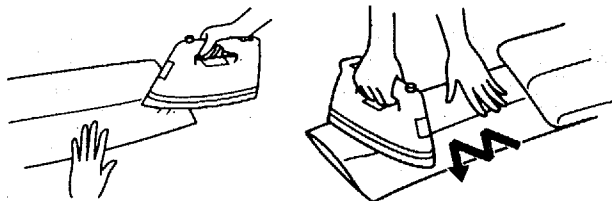

1. Fit the outer and inner seams of the leg together, from bottom edge to crotch, hold so it does not move, and iron the edge with pressure.

2. Move the iron in a zigzag motion, mainly along the seam, position the crease line, then iron the crease with pressure.
3. Use the rounded end of the ironing table when ironing the hip and waist areas of slacks.

3.2.2.4. Ironing tips

1. "New" synthetic fiber and knitted products Iron lightly from the inner side of the item.
Do not iron directly on the outside of the item.
2. Pleated polyester products No ironing is needed.
3. Embroidered products Embroidered parts shrink easily.
Therefore, apply finishing ironing to the embroidered product when it is wet. (If the embroidered product has dried, spray the item to dampen it, then iron to finish).
4. Corduroy and similar fabrics Apply steam all over the surface of pile products and long-hair or raised-finish products, while holding the iron so it floats just above the surface of the fabric.
5. When you want to stiffen fabric When you want a linen (or cotton, etc.) product to have a neat, crisp finish, mix water and synthetic starch together in the tub, immerse and press down the linen product, etc., to soak it with the starch solution, then spin [40 seconds].
6. If lint clings to clothing Use cellophane tape to remove lint, loose threads, etc.

3.2.3. When this occurs

3.2.3.1. How to fix shrinkage

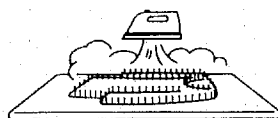
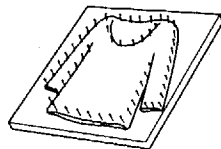

On a wide ironing board, stretch the shrunk item to the desired dimensions and use straight pins to pin it in place. Hold the iron so it floats above the clothing, apply steam liberally to the item, then leave it as-is until dry. (If you have purchased clothing that you suspect might shrink, it's a good idea to make a tracing of it before washing it, so correcting for shrinkage will be easier.)

4 DISASSEMBLY INSTRUCTIONS AND ADJUSTMENTS

WARNING

BEFORE ATTEMPTING TO SERVICE OR ADJUST ANY PART OF THE MACHINE, DISCONNECT THE ELECTRICAL POWER SUPPLY FROM THE WALL OUTLET.

4.1. Caution to be observed when trouble shooting

1. Electronic components of the print circuit board is MOS TYPE FET. When replace and trouble shooting of the print circuit board, Make sure body is grounded before beginning repair work. But, in case can not ground, touch to the plug and earth wire, And remove the potential difference between the set and body of the worker completely.

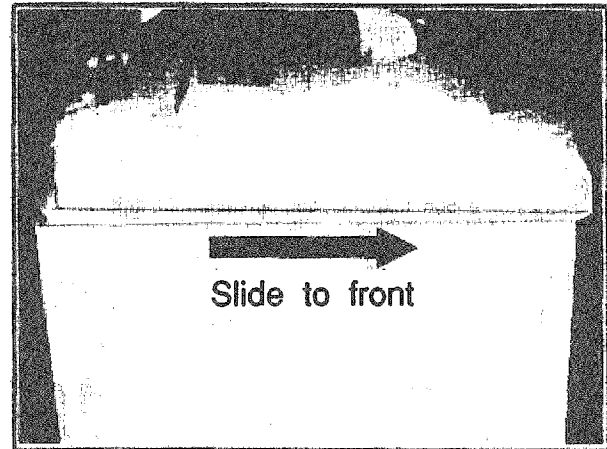
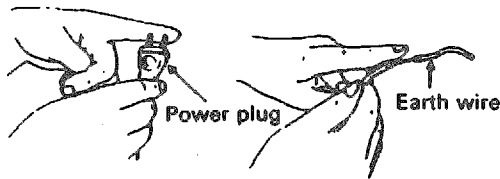

2. Slide to front-ward to remove the body B. (Front portions are held by pawls.)

4.1.1. Print circuit board

1. Print circuit board has been coated with urethane resin to improve moisture resistant. Therefore electronic components on the print circuit board can not replace and trouble shooting.
2. When replace the P.C.Board, do not scratch the P.C.Board, do not scratch the surface of the P.C.Board.

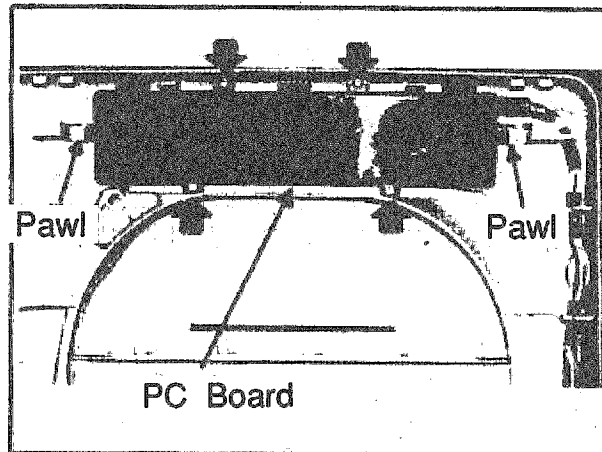
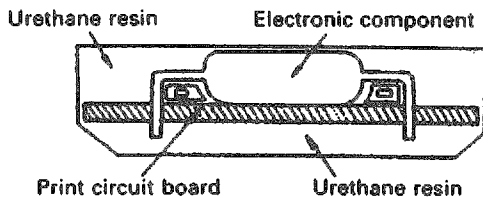

3. Remove screws mounting the PC Board and remove both pawls.

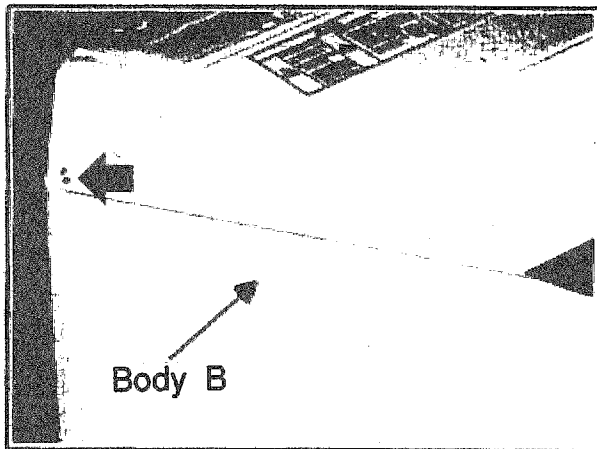

1. Remove 2 screws mounting the body B. (Rear portion)

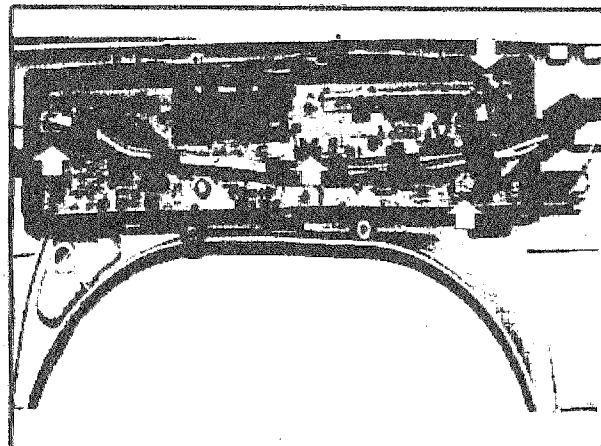

4. Remove connectors from the PC Board.
5. Remove the lead wire holder.

NOTE

Hold the wire connectors properly, incase to remove connectors from the PC Board.

**4.1.2. Water level detector, Safety switch
Feed valve replacement.**

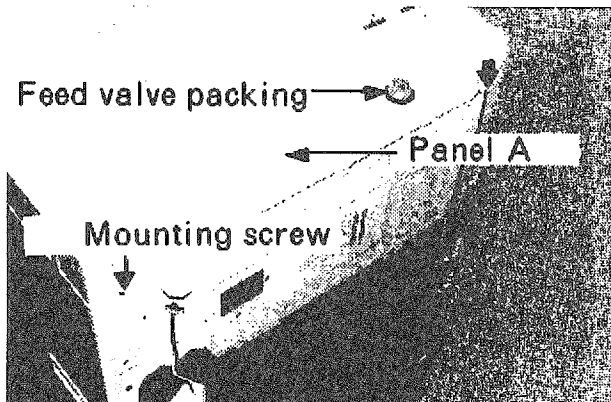

1. Remove 2 screws mounting the panel A.
*Do not lost the feed valve packing when removing the panel A.

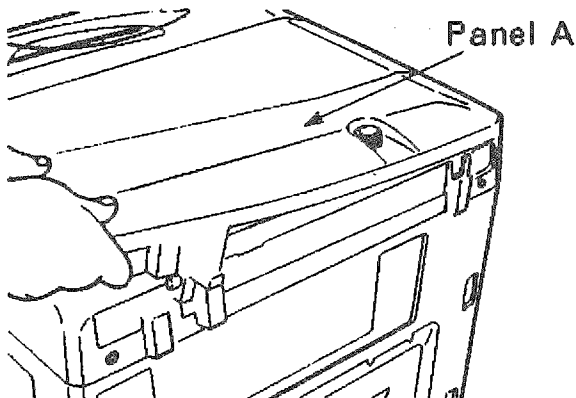

2. Panel A has been installed with screws and pawls. After remove 2 screws, insert screw driver and pull the panel A to up-ward to remove.

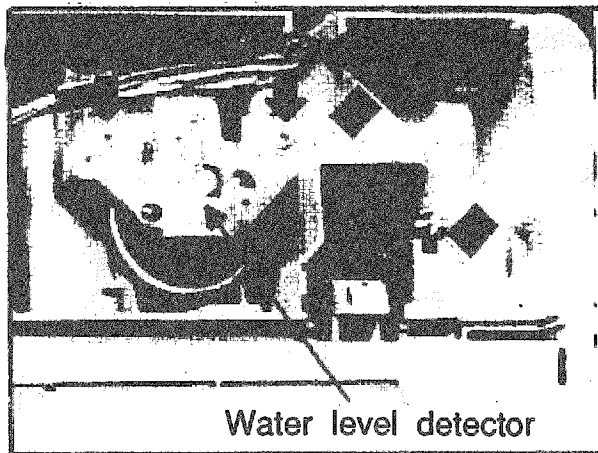

3. Remove 2 screws mounting the water level detector.
4. Remove lead wire connector.
5. Remove the air hose.

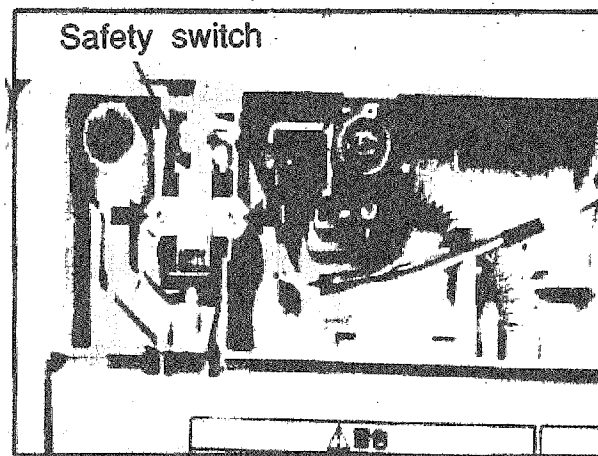

- Safety switch replacement
3. Remove 2 screws mounting the safety switch.
 4. Remove lead wire connector.

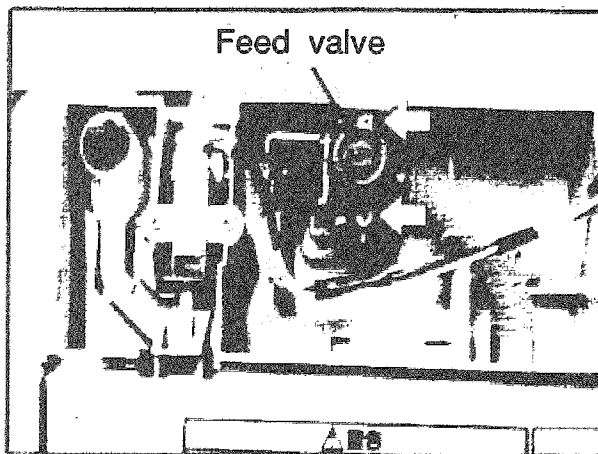

- Feed valve replacement
3. Remove 2 screws mounting the feed valve.
 4. Remove lead wire connector.
 5. Remove feed hose properly.

4.1.3. Mechanism case replacement

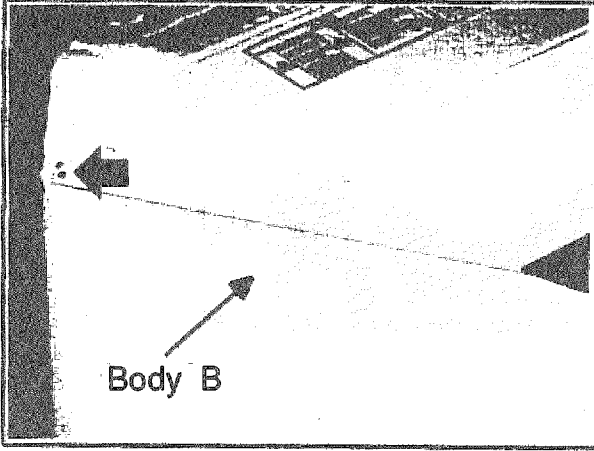

1. After remove mounting screws of the body B.
2. Slide to front to remove the body B.

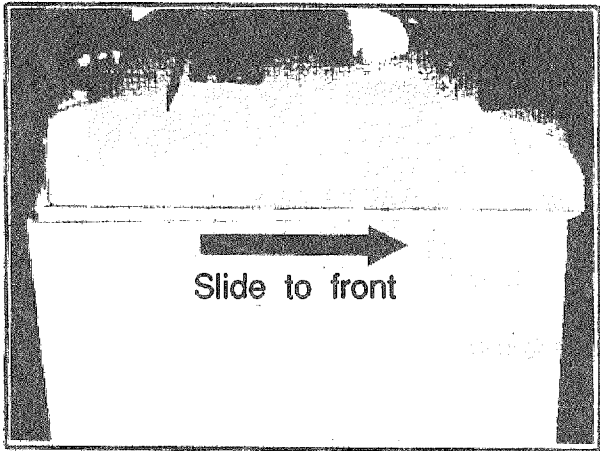

3. Rise up the body B against the wall as shown in figure.

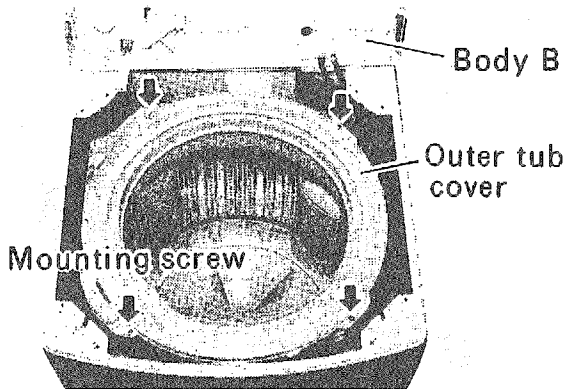

4. Remove 4 screw mounting the outer tub cover.
5. Remove a screw mounting the pulsator.
*Do not remove screw mounting the pulsator completely, and pull up-ward to remove.

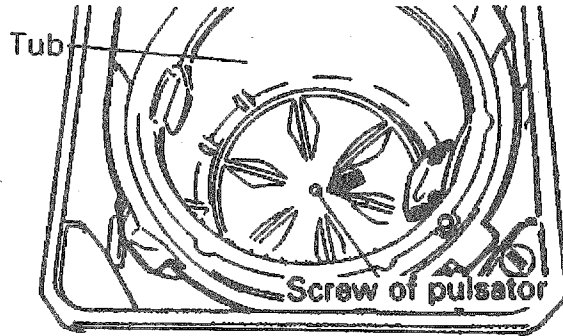

6. Remove a screw mounting the pulsator.
*Do not remove screw mounting the pulsator completely, and pull up-ward to remove.

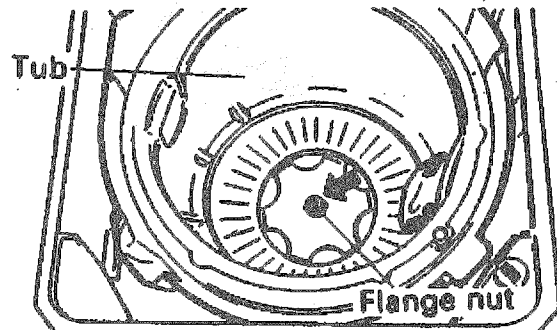

7. Remove the spinner shaft flange nut by using nut remover HW-25K. And remove the spinner shaft washer B.

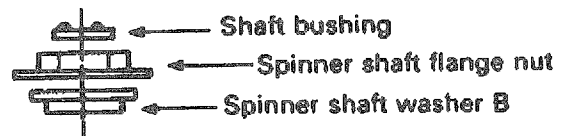

8. Pull up the tub upward to remove.

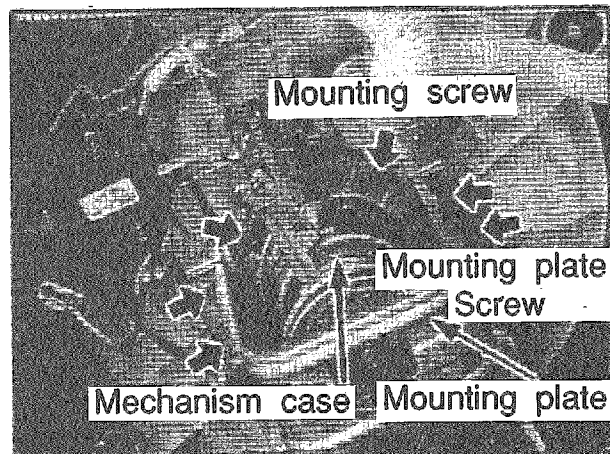

9. Place the machine on its front side.
10. Remove 4 screws mounting the spinner plate B.
11. Remove 4 screws mounting the mechanism case.

5 CHECK INPUT AND OUTPUT VOLTAGE OF THE P.C BOARD

1. Before replace P.C Board, check input and output voltage of the P.C. Board.
2. Check range of the test meter.
3. When check output voltage of the P.C. Board, set a program of the washer as shown in figure.

Checking part name		Setting a program
1	• Feed valve	• Turn on the power switch (Select sw.) and push the START/HOLD switch
2	• Motor	• Turn on the power switch (Select sw.) and set B-Process of the test running without water.
3	• Motorized drain valve • Pump	• Turn on the power switch (Select sw.) and set C-Process of the test running without water.

5.1. Measure output voltage of the electrical parts connector's on the P.C Boaed.

5.2. Measure each resistance after removed connectors.

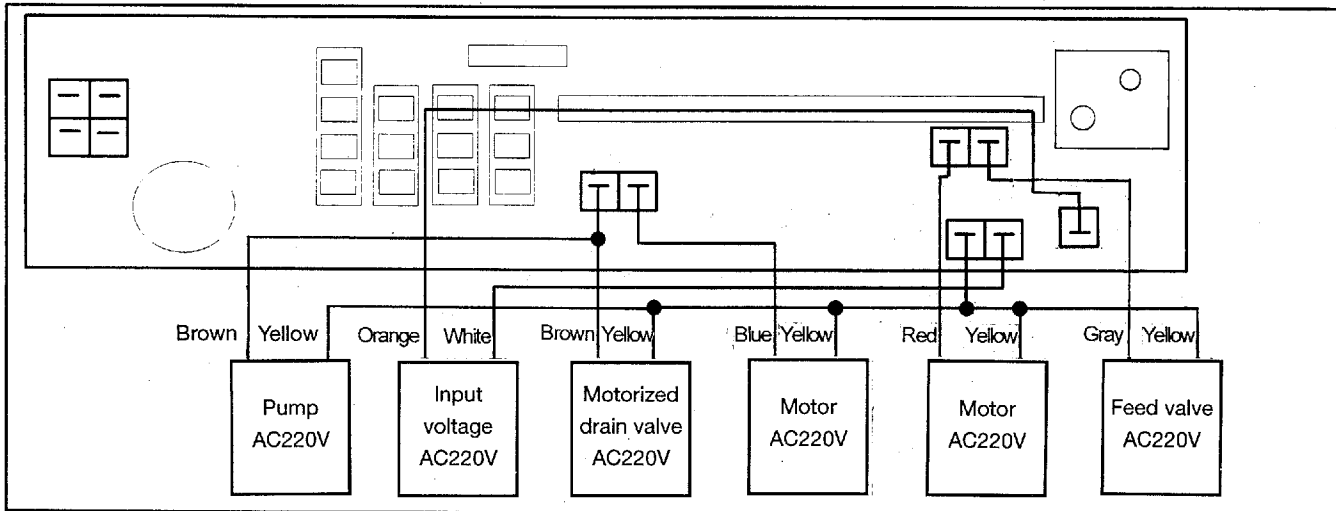

6 TEST RUNNING WITHOUT WATER

6.1. METHOD TO TEST RUNNING WITHOUT WATER

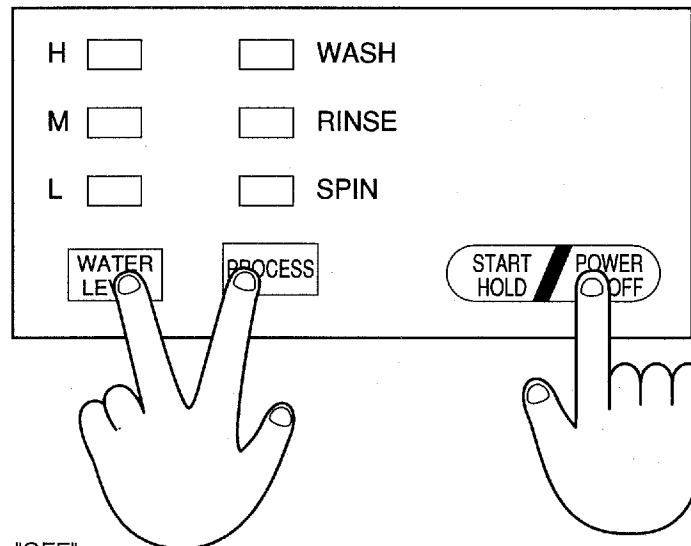

1. Set the power switch to "OFF".
2. Press and hold both the "Water level" and "Wash" buttons with one hand.
3. Set the power switch to "ON".
4. Release the your fingers from the bottoms and power switch which you pressed in steps (2) and (3) above. (Check A can be carried out in this state with your fingers released.)
5. Within three seconds, press the "Water level" button to set to the desired check procedure. (Carry out checks B and C)

Number of times the "Water level" button is pressed	Check Procedure	Check contents	Lamp illumination condition	Operation condition
0	A	<ul style="list-style-type: none"> • End signal • Remaining time indication • Auto power-off 	H <input checked="" type="checkbox"/> <input checked="" type="checkbox"/> WASH <input type="checkbox"/> RESERVE M <input type="checkbox"/> <input checked="" type="checkbox"/> RINSE <input checked="" type="checkbox"/> NORMAL L <input type="checkbox"/> <input checked="" type="checkbox"/> SPIN <input type="checkbox"/> SOAK	<ul style="list-style-type: none"> • When the end buzzer sounds three times, process lamps will simultaneously flash on and off, and the power will automatically be switchde off immediately after operation is finished.
1	B	<ul style="list-style-type: none"> • Wash operation • Feed valve 	H <input checked="" type="checkbox"/> <input checked="" type="checkbox"/> WASH <input type="checkbox"/> RESERVE M <input type="checkbox"/> <input type="checkbox"/> RINSE <input checked="" type="checkbox"/> NORMAL L <input type="checkbox"/> <input type="checkbox"/> SPIN <input type="checkbox"/> SOAK	<ul style="list-style-type: none"> • Even if there is no water in the tub, the washing operation will continue for six minutes.
2	C	<ul style="list-style-type: none"> • Spin operation • Lid switch operation 	H <input type="checkbox"/> <input type="checkbox"/> WASH <input type="checkbox"/> RESERVE M <input type="checkbox"/> <input type="checkbox"/> RINSE <input checked="" type="checkbox"/> NORMAL L <input type="checkbox"/> <input checked="" type="checkbox"/> SPIN <input type="checkbox"/> SOAK	<ul style="list-style-type: none"> • The spinning operation will continue for five minutes. • It is possible to check conditions of lid switches. Check condition of the LED when the below switches become OFF position. Lead sw. → "L" light up on water level. Safety sw. → "M" light up on water level. • In case to press the process button, Lead sw. become ON position compulsory.

7 SCHEMATIC DIAGRAM

7-1 For Chile

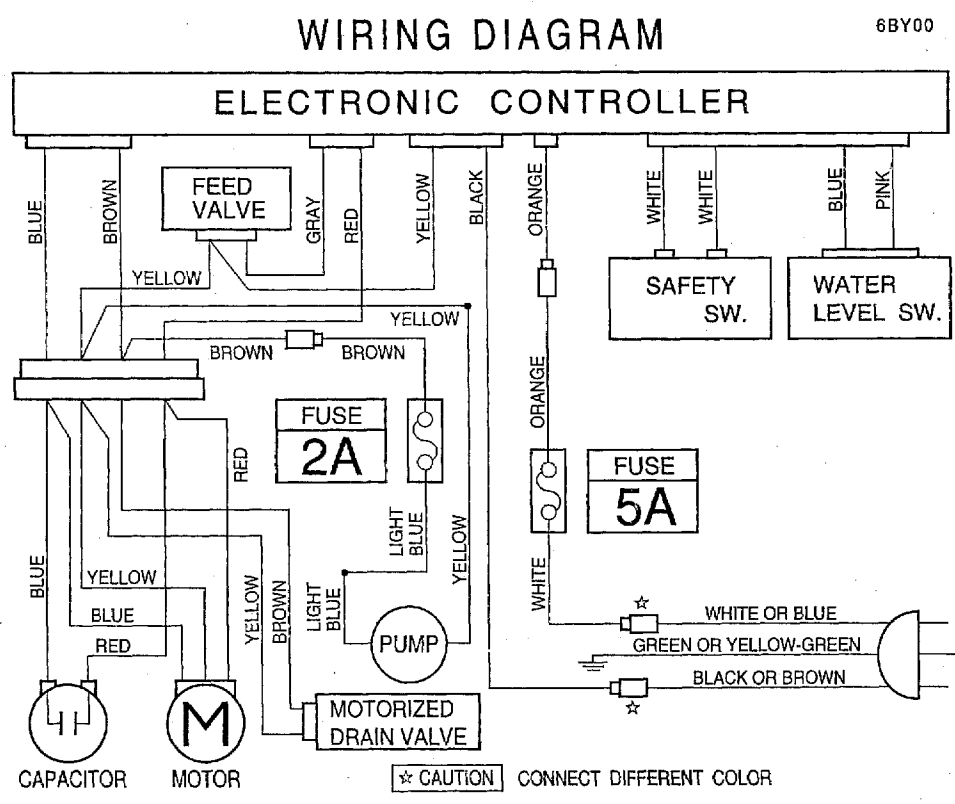

7-2 For Hong Kong, Russia

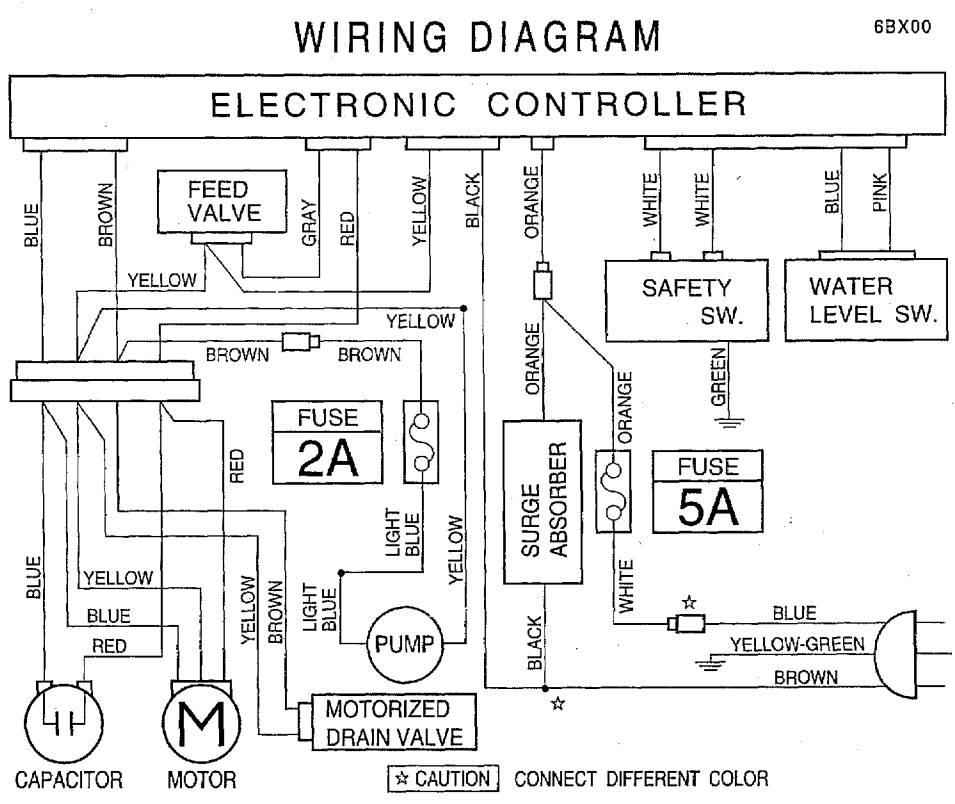

LOCATION OF PARTS-A

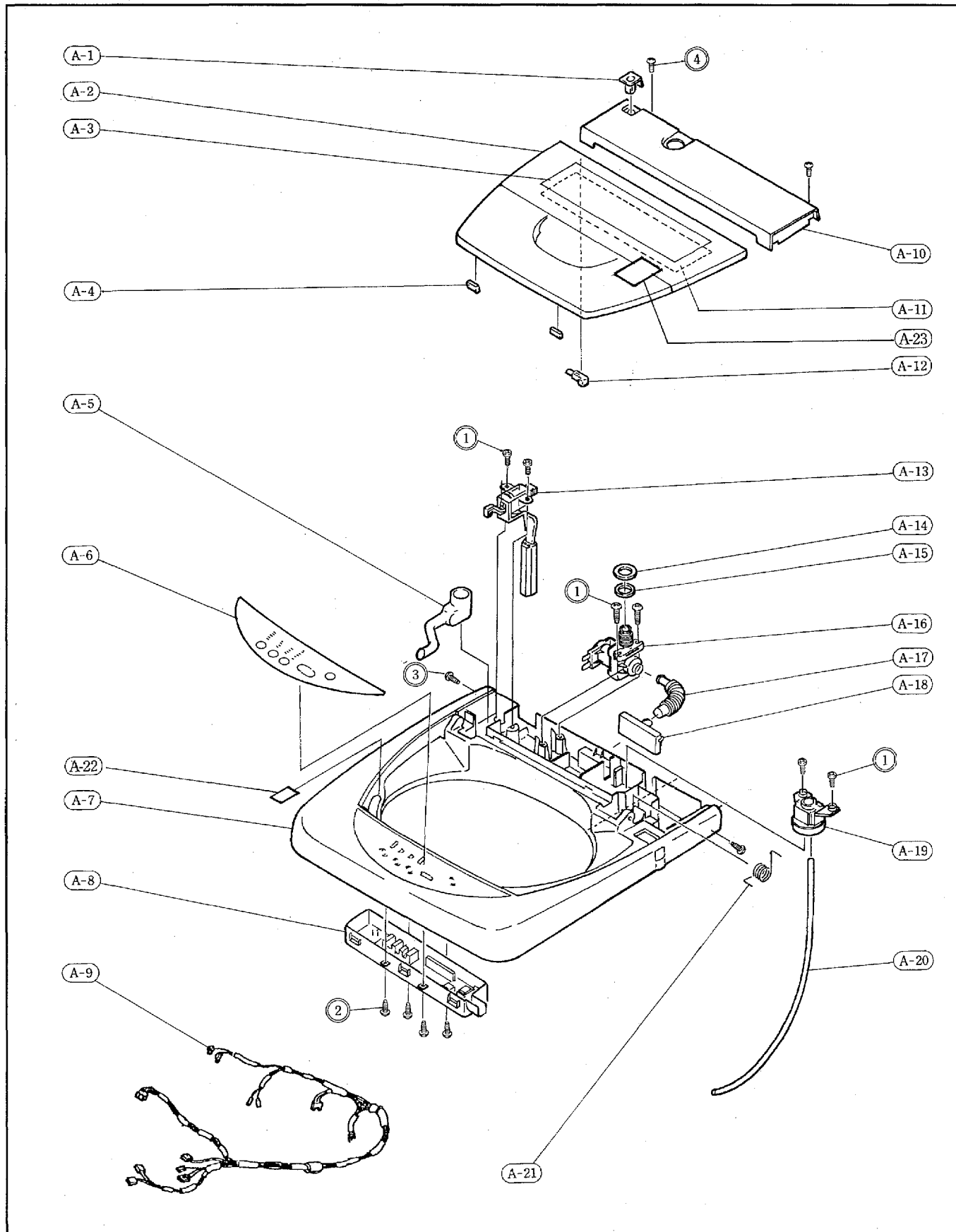

REPLACEMENT PARTS LIST-A

REF NO.	PART NAME & DESCRIPTION	PART NO.	PCS/SET	REMARKS
A-1	Cap A	AXW514X5TW0	1	Beige
A-1	Cap A	AXW514U5TW0	1	Gray
A-2	Lid	AXW1GX6BY00	1	Beige (Inc.A-3,4,11,12)
A-2	Lid	AXW1GZ6BW00	1	Gray (Inc.A-3,4,11,12)
A-3	Lid label	AXW1117Z6CT0	1	For Chile, Russia
A-3	Lid label	AXW1117Z6CR0	1	For H.K
A-4	Lid packing	AXW164W59U0	2	Beige
A-4	Lid packing	AXW164W59U5	2	Gray
A-5	Drain pipe	AXW205-5TW0	1	
A-6	Panel face B	AXW146-6BY00	1	F5510P, Chile
A-6	Panel face B	AXW146-6BX70	1	F50E1P/H.K
A-6	Panel face B	AXW146-6BZ00	1	F50E1P/Russia
A-7	Body B	AXW1BX6BY00	1	F5510P Beige (Inc.A-6)
A-7	Body B	AXW1BX6BZ00	1	F50E1P Beige (Inc.A-6)
A-7	Body B	AXW1BZ6BX70	1	F50E1P Gray (Inc.A-6)
A-8	PC Board w/component	AXW24C-6BW04	1	AC220V/50Hz
A-9	Lead wire	AXW14B-6BY00	1	For upper, Chile
A-9	Lead wire	AXW14B-6BZ00	1	For upper, H.K/Russia
A-10	Panel A	AXW1CX6AX00	1	Beige
A-10	Panel A	AXW1CZ6AX00	1	Gray
A-11	Caution label	AXW9908Z6BY0	1	For Chile, Russia
A-11	Caution label	AXW9908Z6BW0	1	For H.K
A-12	Lid hinge shaft	AXW193W5U80	1	
A-13	Safety switch	AXW1661-5NS0	1	
A-14	Feeding port packing	AXW267-2431	1	
A-15	Feed valve case	AXW2919-5TW0	1	
A-16	Feed valve	AXW29A-15106	1	AC220V/50Hz
A-17	Feed hose	AXW1260-5970	1	
A-18	Feeding port	AXW204-8160	1	
A-19	Water level detector	AXW24T-140	1	
A-20	Air hose	AXW239-8340	1	
A-21	Lid hinge shaft	AXW1116-6AG0	1	
A-22	Label	AXW9958Z6BY0	1	Bleach inlet (Eng/Spa)
A-22	Label	AXW9958Z6BW0	1	Bleach inlet (Eng/ 広東)
A-23	Caution label	AXW9958Z6BZ0	1	Child lock(Eng/Spa)
A-23	Caution label	AXW9958Z6BX0	1	Child lock(Eng/ 広東)

LOCATION OF PARTS-B

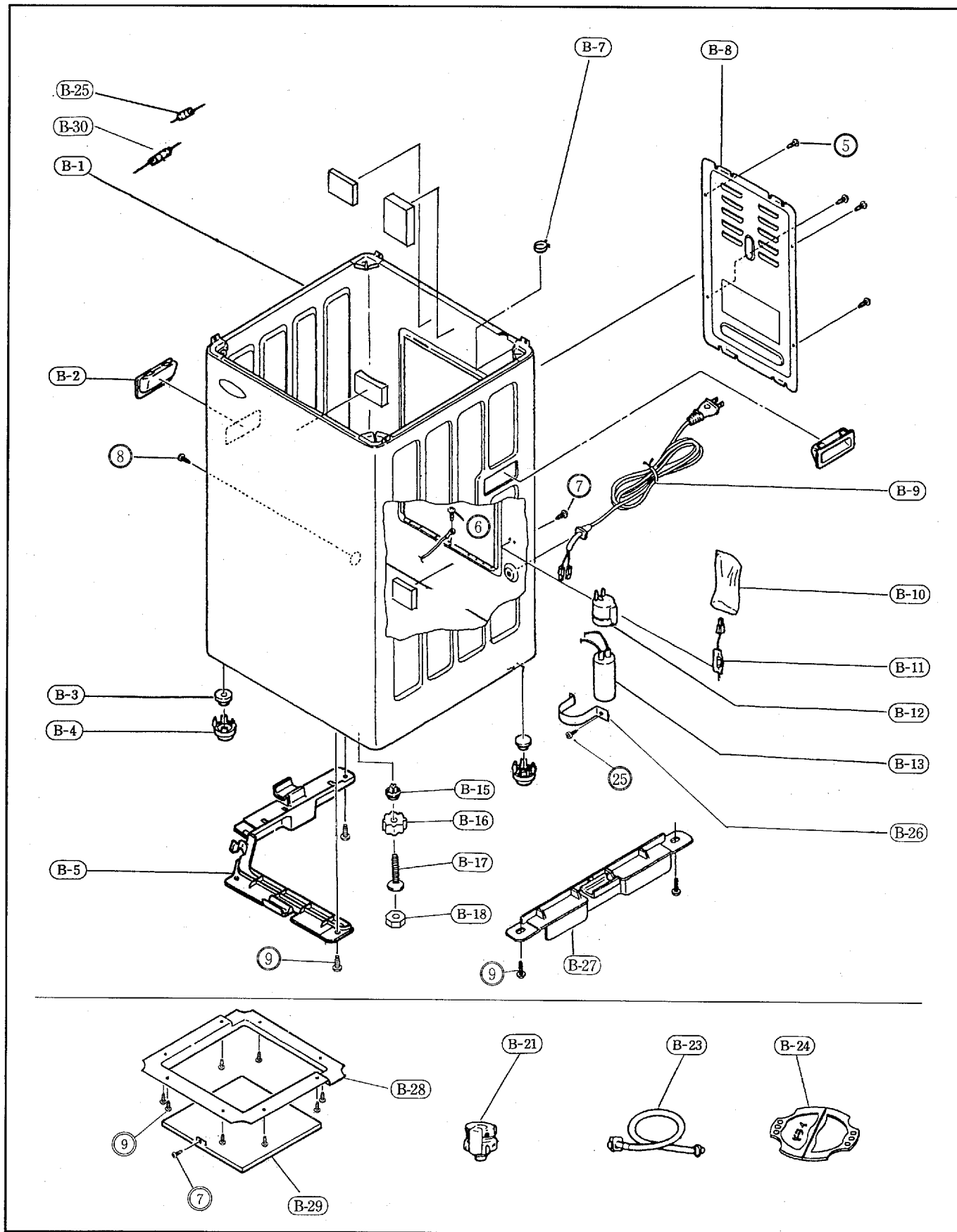

REPLACEMENT PARTS LIST-B

REF NO.	PART NAME & DESCRIPTION	PART NO.	PCS/SET	REMARKS
B-1	Body A	AXW1AX6BXA0	1	Beige
B-1	Body A	AXW1AZ6BXA0	1	Gray
B-2	Body hanger	AXW110X5R7X	2	Beige
B-2	Body hanger	AXW110U5R7Z	2	Gray
B-3	Leg cover	AXW339-5YW0	3	
B-4	Leg mounting plate	AXW341-5U80	3	
B-5	Bottom plate	AXW2158-6AG0	1	For Chile
B-7	Snap pin A	AXW334-5U90	1	
B-8	Back panel	AXW156-5210	1	
B-9	Power cord	—————	1	
B-10	Cover	AXW448-5TP0	1	
B-11	Fuse	AXW14C-11000	1	5A, For Chile
B-11	Fuse	AXW14C-11100	1	5A, For H.K, Russia
B-12	Capacitor cap	AXW407-5U80	1	
B-13	Capacitor	AXW403-7C107		AC220V/50Hz
B-15	Adjustable leg holder	AXW337-56R0	1	
B-16	Adjustable leg knob	AXW343-5YW0	1	
B-17	Adjustable leg	AXW335-56R0	1	
B-18	Adjustable leg plate	AXW342-56R0	1	
B-21	Feed valve joint A	AXW12H-9025	1	
B-23	Pressure hose	AXW1251-9065	1	1.5m
B-24	Laundry net	AXW2W-5TW0	1	
B-25	Fuse	AXW14C-11200	1	2A (Pump-PCB)
B-26	Capacitor bracket	AXW404-5U80	1	
B-27	Bottom plate	AXW2158-5S90	1	For Chile
B-28	Bottom plate	AXW2159Z5XP0	1	For H.K, Russia
B-29	Bottom plate	AXW340-5Y800	1	For H.K, Russia
B-30	Surge absorber	AXW24M-6BW00	1	For H.K, Russia

REPLACEMENT PARTS LIST-C

REF NO.	PART NAME & DESCRIPTION	PART NO.	PCS/SET	REMARKS
C-1	Outer tub cover	AXW3324-6AG0	1	
C-2	O-ring	AXW257-59U0	1	
C-3	Pulsator	AXW5E-6AG0	1	
C-4	Shaft bushing	AXW504-59V0	1	
C-5	Spinner shaft nut	AXW1517-5U90	1	
C-6	Spinner shaft washer B	AXW1519-8020	1	
C-7	Tub	AXW2A-6AG0	1	(Inc.C-8,17)
C-8	Lint filter	AXW22A-6AA0	1	
C-9	Outer tub	AXW12A-6AG0	1	(Inc.C-11)
C-10	Suspension	AXW340Z-6AG0	1	1set=4pcs.
C-14	Outer tub plate B	AXW1202-5TW0	1	
C-15	Motor	AXW401-52804	1	AC220V/50Hz
C-16	Motor pulley	AXW411-59P0	1	50 · 60Hz Common
C-17	Rinse case	AXW21D-6AG0	1	
C-24	Motorized drain valve	AXW3482Z2206	1	AC220V/50Hz
C-26	Mechanism case	AXW20A-6AG0	1	(inc.C-27~30)
C-27	Spinner pulley metal	AXW1532-59U0	1	
C-28	Clutch spring	AXW454-59U0	1	
C-29	Clutch boss A	AXW452-6AG0	1	
C-30	Pulsator pulley	AXW502-8220	1	
C-31	Leadwire	AXW14B-6BY50	1	For lower
C-32	V-Belt	AXW412-1985	1	
C-33	Outer tub mounting plate B	AXW3232-5TW0	1	
C-39	Drain hose A	AXW230-76700	1	
C-40	Drain hose B	AXW231-5SS00	1	
C-41	Valve bracket	AXW925-76500	1	
C-42	Slider guide	AXW633-68800	1	
C-43	Magnet cushion	AXW2115Z6882	1	
C-44	Hose clamp	AXW245-53700	1	
C-45	Hose clamp	AXW245-5420	3	
C-46	Hose clamp	AXW2I-110	1	
C-47	Service hose	AXW2D-68800	1	1.2m
C-48	Hose clamp	AXW245-2860	1	
C-49	Hose supporter	AXW279-27800	1	
C-50	Valve spring B	AXW971-76500	1	
C-52	Valve rod A	AXW932-5WZ00	1	
C-54	Pump bracket	AXW828-6BX00	1	
C-55	Drain pump	AXW8C-76504	1	AC 220V/50Hz
C-56	Motor cover	AXW402-5WZ00	1	
C-57	Pump bracket	AXW828-76550	1	
C-58	Sponge	AXW3254Z5WZ0	1	
C-59	Filter flame	AXW2205Z7670	1	
C-60	Filter cover	AXW2208Z6120	1	
C-61	Cushion	AXW9046Z5SS0	1	
---	Operating instruction	AXW9901Z6BY0	1	F5510P, Chile
---	Operating instruction	AXW9901Z6BX7	1	F50E1P, H.K
---	Operating instruction	AXW9901Z6BZ0	1	F50E1P, Russia
---	Installation instruction	AXW9903Z6BX0	1	F50E1P, H.K
---	Installation instruction	AXW9903Z6BZ0	1	F50E1P, Russia
---	Installation instruction	AXW9903Z6BY0	1	F5510P, Chile

SMALL STANDARDIZED METAL PARTS

REF NO.	PART NAME	PART NO.	PCS/SET	REMARKS
1	Screw	XTB4+15BU	6	
2	Screw	XTB4+15BV	4	
3	Screw	XTWAXW417	2	
4	Screw	XTB4+20BFE	2	
5	Screw	XTBAXW414	4	
6	Screw	XTN4+8B	1	
7	Screw	XTB4+15B	2	
8	Screw	XTWAXW425	1	
9	Screw	XTT4+14B	12	
10	Screw	XTWAXW435	4	
11	Screw	XSSAXW805	1	
12	Screw	XWCAXW851	1	
13	Screw	XTWAXW6504	9	
14	Bolt	XTWAXW511	2	
15	Bolt	XVGAXW658AE	4	
16	Nut	XNGAXW701	1	
17	Bolt	XVGAXW705	1	
18	Bolt	XVGAXW401S	1	
19	Bolt	XVGAXW812AE	4	
20	Screw	XTWAXW6506	3	
21	Nut	XNGAXW1001	1	
26	Screw	XTB4+15BFN	3	
27	Screw	XSN4+10S	3	
28	Screw	XTN5+16	3	
29	Screw	XTB4+6BFN	1	
30	Screw	XTB4+8BFN	1	
31	Screw	XTWAXW6507	2	